

# 6" Partition Modules

## Features:

- 6" Partition Modules can be used as Island Modules, or as a Partition System
- 6" Partition Modules provide support for a wide combination of accessories, including:
  - adjustable worksurface frames
  - adjustable tables
  - hanging cabinetry — upper and lower
  - floor mounted cabinetry
  - adjustable shelving
  - lighting
  - electrical and plumbing raceway
  - service drops
  - tack boards and marker boards
- 6" Partition Modules provide 3½" of service space and are built to receive standard pipe hangers for ease of installing service piping and electrical conduit.
- System design allows shelving to be suspended both above and below the worksurface.
- Easy and positive structural alignment and attachment to adjacent modules.
- Available with easy to remove access panels. May be ordered without access panels for use with floor mounted base cabinets.

## SEFA 10 | Class 5 – Configuration 2 – Category 2

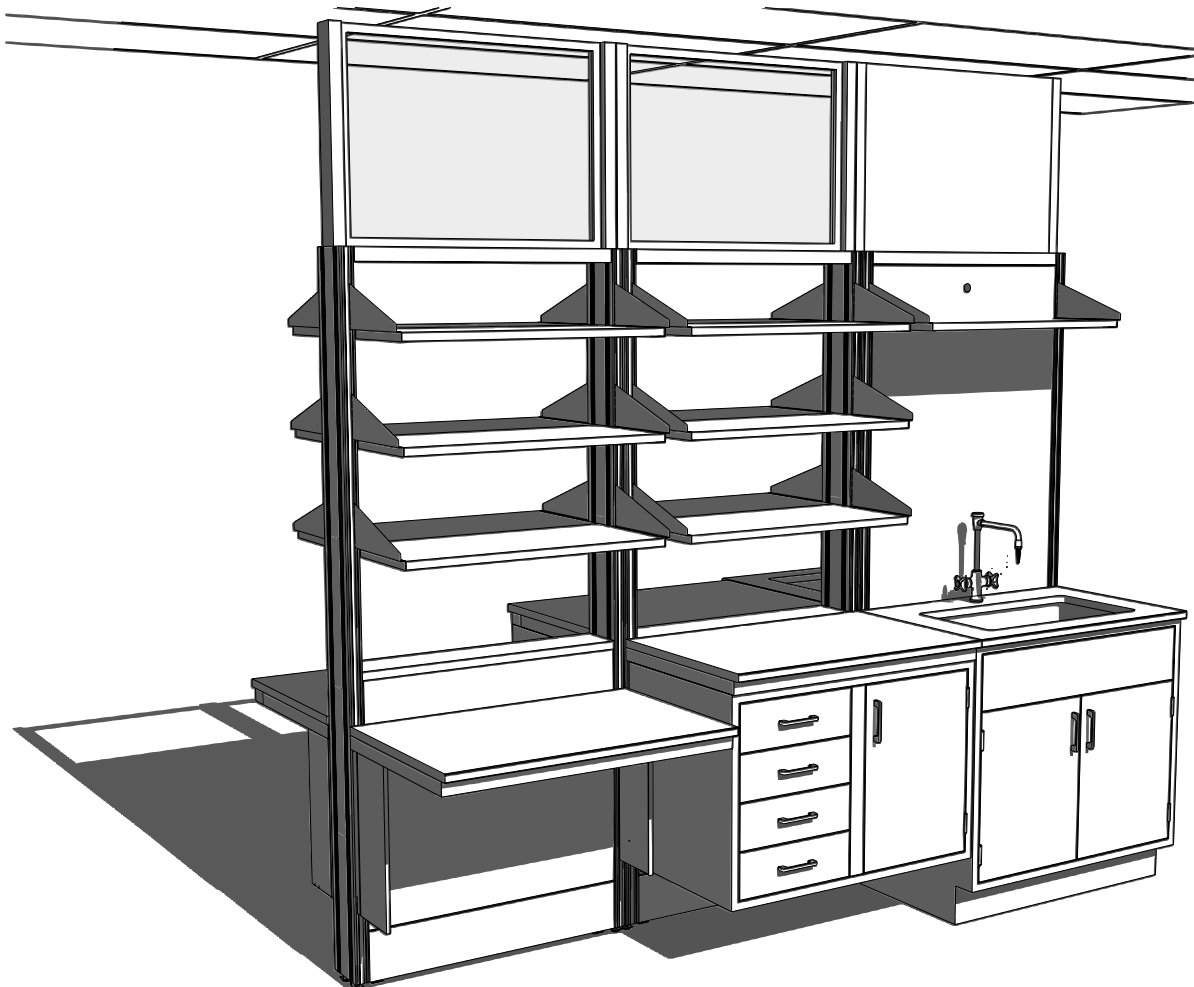

# 6" Partition Modules

## Specifications:

6" Partition Modules are 37" high, with Upper Carriers, 84" high. Both are 6" deep and available in lengths shown.

Modules are available with or without Access Panels. Order without when used with floor mounted base cabinets.

Each module is furnished with hardware for attaching adjacent modules.

**Ceiling Support and Module Ledge must be ordered separately.**

### 6" Deep Partition Module – 37" High

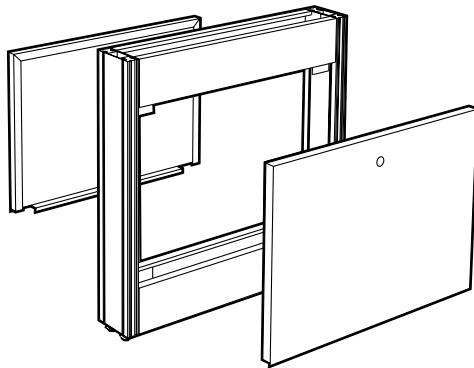

Length	with Access Panels	without Access Panels
24"	<b>F08M3724-00</b>	<b>F08-3724-00</b>
30"	<b>F08M3730-00</b>	<b>F08-3730-00</b>
36"	<b>F08M3736-00</b>	<b>F08-3736-00</b>
42"	<b>F08M3742-00</b>	<b>F08-3742-00</b>
48"	<b>F08M3748-00 *</b>	<b>F08-3748-00</b>
54"	<b>F08M3754-00 *</b>	<b>F08-3754-00</b>
60"	<b>F08M3760-00 *</b>	<b>F08-3760-00</b>
66"	<b>F08M3766-00 *</b>	<b>F08-3766-00</b>
72"	<b>F08M3772-00 *</b>	<b>F08-3772-00</b>

\* Modules 48" long and over are provided with two half-length Access Panels.

### 6" Deep Partition Module with Upper Carrier – 84" High

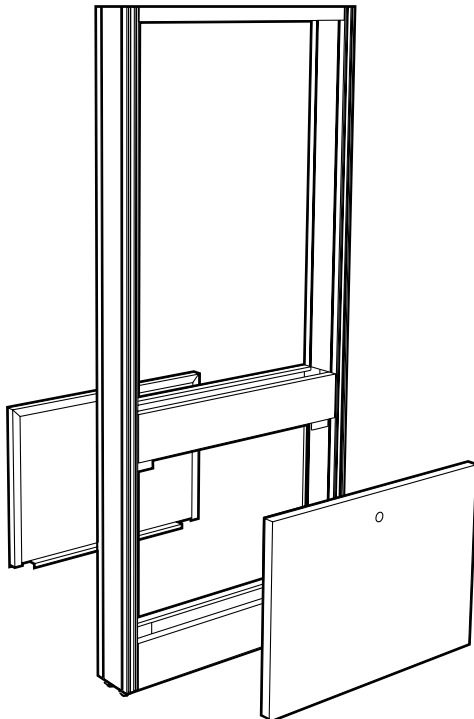

Length	with Access Panels	without Access Panels
24"	<b>F38M3724-00</b>	<b>F38-3724-00</b>
30"	<b>F38M3730-00</b>	<b>F38-3730-00</b>
36"	<b>F38M3736-00</b>	<b>F38-3736-00</b>
42"	<b>F38M3742-00</b>	<b>F38-3742-00</b>
48"	<b>F38M3748-00 *</b>	<b>F38-3748-00</b>
54"	<b>F38M3754-00 *</b>	<b>F38-3754-00</b>
60"	<b>F38M3760-00 *</b>	<b>F38-3760-00</b>
66"	<b>F38M3766-00 *</b>	<b>F38-3766-00</b>
72"	<b>F38M3772-00 *</b>	<b>F38-3772-00</b>

\* Modules 48" long and over are provided with two half-length Access Panels.

# 6" Partition Modules

## Specifications:

Service Riser Partition Modules are 47" high, with Upper Carrier, 84" high. Both are 6" deep and in lengths shown.

Modules are available with or without Access Panels. Order without when used with floor mounted base cabinets.

Each module is furnished with hardware for attaching adjacent modules.

**Ceiling Support and Module Ledge must be ordered separately.**

### 6" Deep Service Riser Partition Module – 47" High

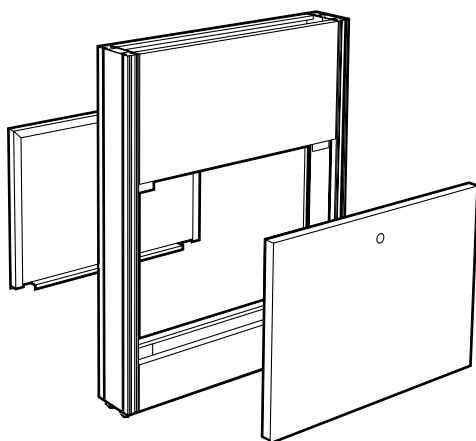

Length	with Access Panels	without Access Panels
24"	<b>F08M4724-00</b>	<b>F08-4724-00</b>
30"	<b>F08M4730-00</b>	<b>F08-4730-00</b>
36"	<b>F08M4736-00</b>	<b>F08-4736-00</b>
42"	<b>F08M4742-00</b>	<b>F08-4742-00</b>
48"	<b>F08M4748-00 *</b>	<b>F08-4748-00</b>
54"	<b>F08M4754-00 *</b>	<b>F08-4754-00</b>
60"	<b>F08M4760-00 *</b>	<b>F08-4760-00</b>
66"	<b>F08M4766-00 *</b>	<b>F08-4766-00</b>
72"	<b>F08M4772-00 *</b>	<b>F08-4772-00</b>

\* Modules 48" long and over are provided with two half-length Access Panels.

### 6" Deep Service Riser Partition Module with Upper Carrier – 84" High

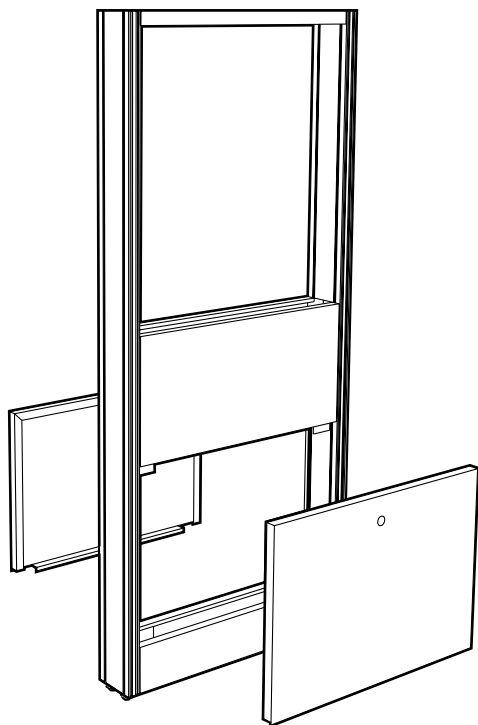

Length	with Access Panels	without Access Panels
24"	<b>F38M4724-00</b>	<b>F38-4724-00</b>
30"	<b>F38M4730-00</b>	<b>F38-4730-00</b>
36"	<b>F38M4736-00</b>	<b>F38-4736-00</b>
42"	<b>F38M4742-00</b>	<b>F38-4742-00</b>
48"	<b>F38M4748-00 *</b>	<b>F38-4748-00</b>
54"	<b>F38M4754-00 *</b>	<b>F38-4754-00</b>
60"	<b>F38M4760-00 *</b>	<b>F38-4760-00</b>
66"	<b>F38M4766-00 *</b>	<b>F38-4766-00</b>
72"	<b>F38M4772-00 *</b>	<b>F38-4772-00</b>

\* Modules 48" long and over are provided with two half-length Access Panels.

# 6" Partition Modules

## Specifications:

Partition Modules are 37" high, with Upper Carriers, 84" high. Both are 6" deep and available in lengths shown.

Modules are available with or without Access Panels. Order without when used with floor mounted base cabinets.

24" and 30" long modules have two single-gang electric box cutouts, all other sizes have three.

Each module is furnished with hardware for attaching adjacent modules.

**Ceiling Support and Module Ledge must be ordered separately.**

## 6" Deep Standard Partition Module with Electric Cutouts – 37" High

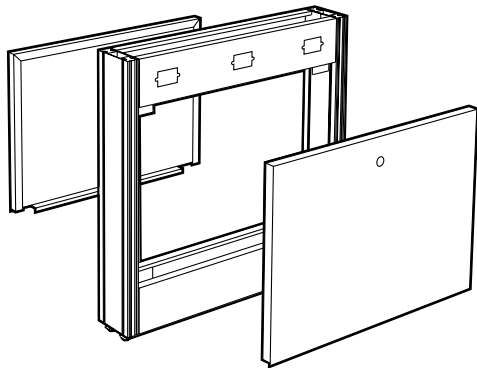

Length	with Access Panels	without Access Panels
24"	<b>F08M3724-E0</b>	<b>F08-3724-E0</b>
30"	<b>F08M3730-E0</b>	<b>F08-3730-E0</b>
36"	<b>F08M3736-E0</b>	<b>F08-3736-E0</b>
42"	<b>F08M3742-E0</b>	<b>F08-3742-E0</b>
48"	<b>F08M3748-E0 *</b>	<b>F08-3748-E0</b>
54"	<b>F08M3754-E0 *</b>	<b>F08-3754-E0</b>
60"	<b>F08M3760-E0 *</b>	<b>F08-3760-E0</b>
66"	<b>F08M3766-E0 *</b>	<b>F08-3766-E0</b>
72"	<b>F08M3772-E0 *</b>	<b>F08-3772-E0</b>

\* Modules 48" long and over are provided with two half-length Access Panels.

## 6" Deep Standard Partition Module with Electric Cutouts & Upper Carrier – 84" High

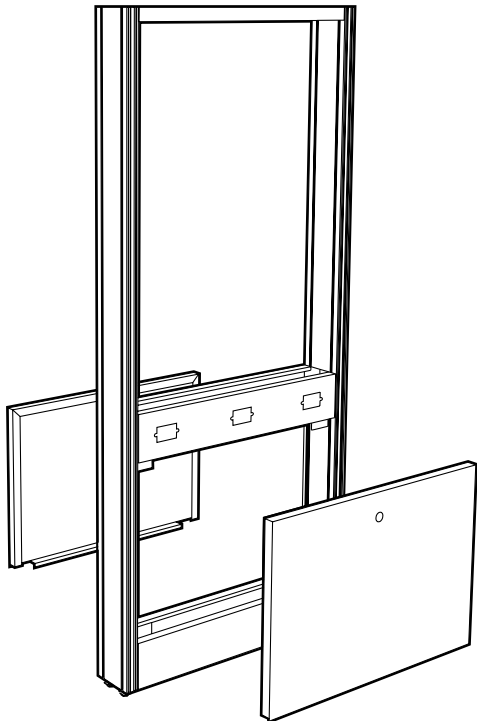

Length	with Access Panels	without Access Panels
24"	<b>F38M3724-E0</b>	<b>F38-3724-E0</b>
30"	<b>F38M3730-E0</b>	<b>F38-3730-E0</b>
36"	<b>F38M3736-E0</b>	<b>F38-3736-E0</b>
42"	<b>F38M3742-E0</b>	<b>F38-3742-E0</b>
48"	<b>F38M3748-E0 *</b>	<b>F38-3748-E0</b>
54"	<b>F38M3754-E0 *</b>	<b>F38-3754-E0</b>
60"	<b>F38M3760-E0 *</b>	<b>F38-3760-E0</b>
66"	<b>F38M3766-E0 *</b>	<b>F38-3766-E0</b>
72"	<b>F38M3772-E0 *</b>	<b>F38-3772-E0</b>

\* Modules 48" long and over are provided with two half-length Access Panels.

# 6" Partition Modules

## Specifications:

Service Riser Partition Modules are 47" high, with Upper Carrier, 84" high. Both are 12" deep and in lengths shown.

Modules are available with or without Access Panels. Order without when used with floor mounted base cabinets.

24" and 30" long modules have two single-gang electric box cutouts, all other sizes have three.

Each module is furnished with hardware for attaching adjacent modules.

**Ceiling Support and Module Ledge must be ordered separately.**

### 6" Deep Service Riser Partition Module with Electric Cutouts – 47" High

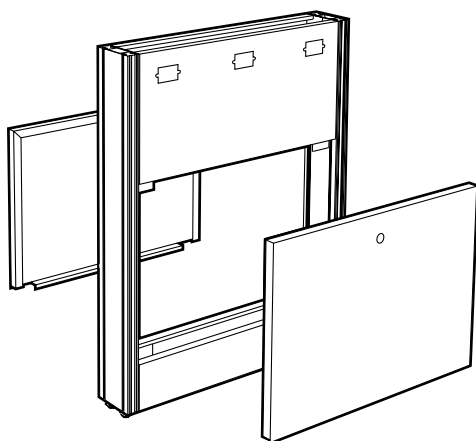

Length	with Access Panels	without Access Panels
24"	<b>F08M4724-E0</b>	<b>F08-4724-E0</b>
30"	<b>F08M4730-E0</b>	<b>F08-4730-E0</b>
36"	<b>F08M4736-E0</b>	<b>F08-4736-E0</b>
42"	<b>F08M4742-E0</b>	<b>F08-4742-E0</b>
48"	<b>F08M4748-E0 *</b>	<b>F08-4748-E0</b>
54"	<b>F08M4754-E0 *</b>	<b>F08-4754-E0</b>
60"	<b>F08M4760-E0 *</b>	<b>F08-4760-E0</b>
66"	<b>F08M4766-E0 *</b>	<b>F08-4766-E0</b>
72"	<b>F08M4772-E0 *</b>	<b>F08-4772-E0</b>

\* Modules 48" long and over are provided with two half-length Access Panels.

### 6" Deep Service Riser Partition Module with Electric Cutouts & Upper Carrier – 84" High

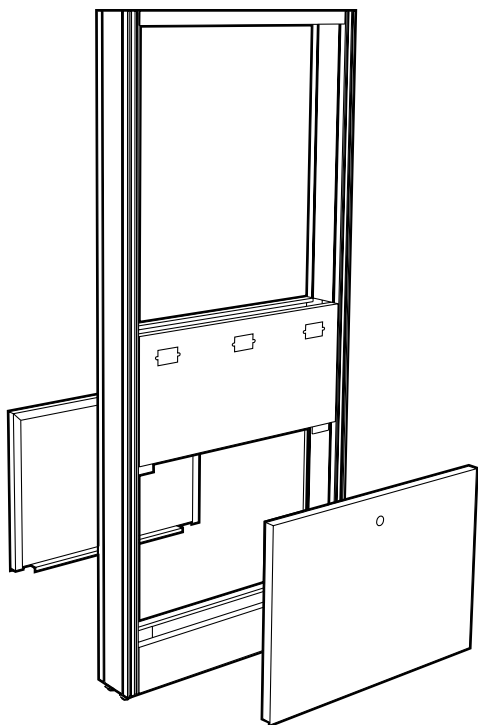

Length	with Access Panels	without Access Panels
24"	<b>F38M4724-E0</b>	<b>F38-4724-E0</b>
30"	<b>F38M4730-E0</b>	<b>F38-4730-E0</b>
36"	<b>F38M4736-E0</b>	<b>F38-4736-E0</b>
42"	<b>F38M4742-E0</b>	<b>F38-4742-E0</b>
48"	<b>F38M4748-E0 *</b>	<b>F38-4748-E0</b>
54"	<b>F38M4754-E0 *</b>	<b>F38-4754-E0</b>
60"	<b>F38M4760-E0 *</b>	<b>F38-4760-E0</b>
66"	<b>F38M4766-E0 *</b>	<b>F38-4766-E0</b>
72"	<b>F38M4772-E0 *</b>	<b>F38-4772-E0</b>

\* Modules 48" long and over are provided with two half-length Access Panels.

# 6" Partition Modules

## Specifications:

Partition Modules with Paneled Upper Carrier are the same as standard Partition Modules; except, they are furnished with easy to remove panels to close off the area between the upper carrier uprights. They may be used as a service drop, to hide piping or tubing, or as a room divider.

When ordered with electric cutouts, 24" and 30" long modules have two single-gang electric box cutouts, all other sizes have three.

Each module furnished with hardware for attaching adjacent modules.

**Ceiling Support must be ordered separately.  
Module Ledge is not required.**

### 6" Deep Standard Partition Module with Paneled Upper Carrier – 84" High

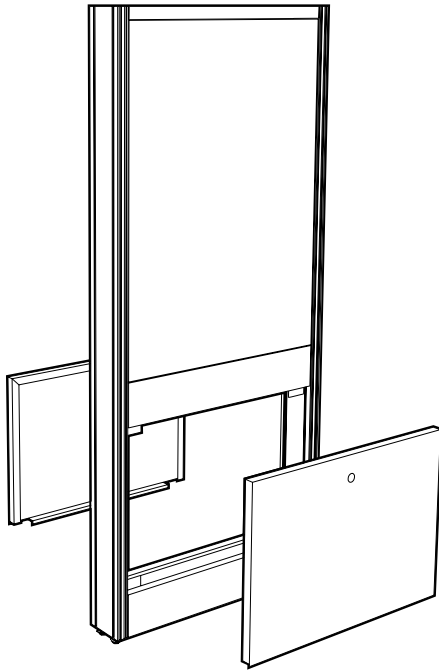

Length	with Lower Access Panels	without Lower Access Panels
24"	<b>F39M3724-00</b>	<b>F39-3724-00</b>
30"	<b>F39M3730-00</b>	<b>F39-3730-00</b>
36"	<b>F39M3736-00</b>	<b>F39-3736-00</b>
42"	<b>F39M3742-00</b>	<b>F39-3742-00</b>
48"	<b>F39M3748-00 *</b>	<b>F39-3748-00 *</b>
54"	<b>F39M3754-00 *</b>	<b>F39-3754-00 *</b>
60"	<b>F39M3760-00 *</b>	<b>F39-3760-00 *</b>
66"	<b>F39M3766-00 *</b>	<b>F39-3766-00 *</b>
72"	<b>F39M3772-00 *</b>	<b>F39-3772-00 *</b>

\* Modules 48" long and over are provided with half-length removable panels.

### 6" Deep Standard Partition Module with Electric Cutouts & Paneled Upper Carrier – 84" High

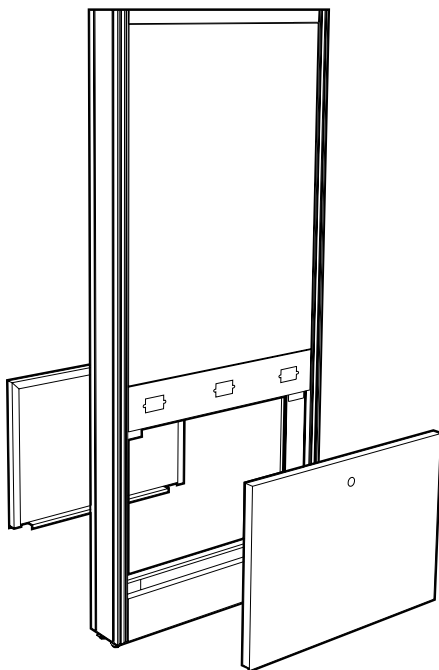

Length	with Lower Access Panels	without Lower Access Panels
24"	<b>F39M3724-E0</b>	<b>F39-3724-E0</b>
30"	<b>F39M3730-E0</b>	<b>F39-3730-E0</b>
36"	<b>F39M3736-E0</b>	<b>F39-3736-E0</b>
42"	<b>F39M3742-E0</b>	<b>F39-3742-E0</b>
48"	<b>F39M3748-E0 *</b>	<b>F39-3748-E0 *</b>
54"	<b>F39M3754-E0 *</b>	<b>F39-3754-E0 *</b>
60"	<b>F39M3760-E0 *</b>	<b>F39-3760-E0 *</b>
66"	<b>F39M3766-E0 *</b>	<b>F39-3766-E0 *</b>
72"	<b>F39M3772-E0 *</b>	<b>F39-3772-E0 *</b>

\* Modules 48" long and over are provided with half-length removable panels.

# 6" Partition Modules

**Specifications:**

Service Riser Partition Modules with Paneled Upper Carrier are the same as standard Service Riser Partition Modules; except, they are furnished with easy to remove panels to close off the area between the upper carrier uprights. They may be used as a service drop, to hide piping or tubing, or as a room divider.

When ordered with electric cutouts, 24" and 30" long modules have two single-gang electric box cutouts, all other sizes have three.

Each module furnished with hardware for attaching to adjacent modules.

**Ceiling Support must be ordered separately.  
Module Ledge is not required.**

**6" Deep Service Riser Partition Module with Paneled Upper Carrier – 84" High**

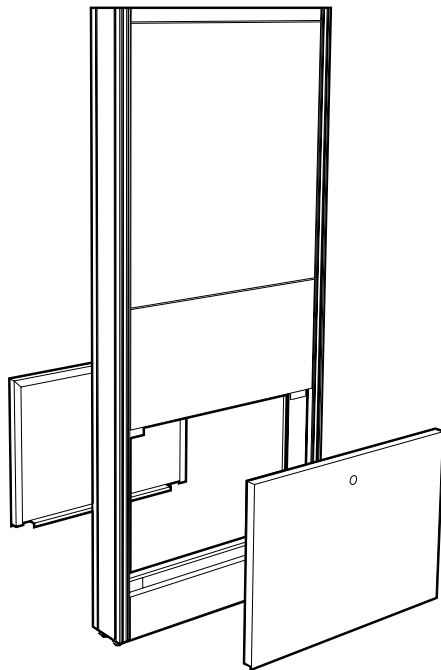

Length	with Lower Access Panels	without Lower Access Panels
24"	<b>F39M4724-00</b>	<b>F39-4724-00</b>
30"	<b>F39M4730-00</b>	<b>F39-4730-00</b>
36"	<b>F39M4736-00</b>	<b>F39-4736-00</b>
42"	<b>F39M4742-00</b>	<b>F39-4742-00</b>
48"	<b>F39M4748-00 *</b>	<b>F39-4748-00 *</b>
54"	<b>F39M4754-00 *</b>	<b>F39-4754-00 *</b>
60"	<b>F39M4760-00 *</b>	<b>F39-4760-00 *</b>
66"	<b>F39M4766-00 *</b>	<b>F39-4766-00 *</b>
72"	<b>F39M4772-00 *</b>	<b>F39-4772-00 *</b>

\* Modules 48" long and over are provided with half-length removable panels.

**6" Deep Service Riser Partition Module with Electric Cutouts & Paneled Upper Carrier – 84" High**

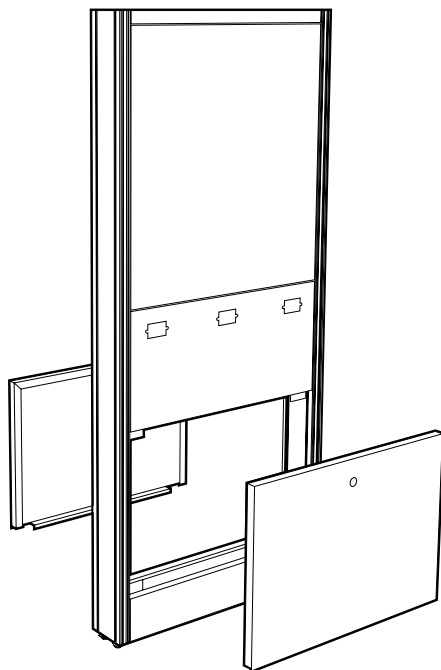

Length	with Lower Access Panels	without Lower Access Panels
24"	<b>F39M4724-E0</b>	<b>F39-4724-E0</b>
30"	<b>F39M4730-E0</b>	<b>F39-4730-E0</b>
36"	<b>F39M4736-E0</b>	<b>F39-4736-E0</b>
42"	<b>F39M4742-E0</b>	<b>F39-4742-E0</b>
48"	<b>F39M4748-E0</b>	<b>F39-4748-E0</b>
54"	<b>F39M4754-E0 *</b>	<b>F39-4754-E0 *</b>
60"	<b>F39M4760-E0 *</b>	<b>F39-4760-E0 *</b>
66"	<b>F39M4766-E0 *</b>	<b>F39-4766-E0 *</b>
72"	<b>F39M4772-E0 *</b>	<b>F39-4772-E0 *</b>

\* Modules 48" long and over are provided with half-length removable panels.

# 6" Partition Modules

## Specifications:

Partition Module Ceiling Supports consist of two cold rolled steel tube assemblies that telescope into the Partition Module Upper Carrier. They are designed to be fastened to channels (provided by others) attached to either the drop ceiling grid or to the roof supports.

Partition Module Ceiling Supports are required when the module is not adjacent to a fixed wall, or supported by a wing wall or fixed furniture.

Ceiling Partitions are available to finish off the space between the Ceiling Supports above the Partition Module to form a continuous floor-to-ceiling divider. They are available in a number of heights and in either glass or with a solid steel panel. Solid partitions may be finished to match the Partition Module or in a contrasting color.

### 6" Deep Partition Module Ceiling Support

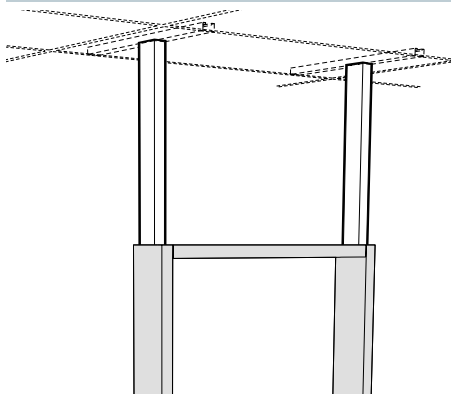

Length	24" High	36" High	48" High	60" High
24"	<b>F48-2424-00</b>	<b>F48-3624-00</b>	<b>F48-4824-00</b>	<b>F48-6024-00</b>
30"	<b>F48-2430-00</b>	<b>F48-3630-00</b>	<b>F48-4830-00</b>	<b>F48-6030-00</b>
36"	<b>F48-2436-00</b>	<b>F48-3636-00</b>	<b>F48-4836-00</b>	<b>F48-6036-00</b>
42"	<b>F48-2442-00</b>	<b>F48-3642-00</b>	<b>F48-4842-00</b>	<b>F48-6042-00</b>
48"	<b>F48-2448-00</b>	<b>F48-3648-00</b>	<b>F48-4848-00</b>	<b>F48-6048-00</b>
54"	<b>F48-2454-00</b>	<b>F48-3654-00</b>	<b>F48-4854-00</b>	<b>F48-6054-00</b>
60"	<b>F48-2460-00</b>	<b>F48-3660-00</b>	<b>F48-4860-00</b>	<b>F48-6060-00</b>
66"	<b>F48-2466-00</b>	<b>F48-3666-00</b>	<b>F48-4866-00</b>	<b>F48-6066-00</b>
72"	<b>F48-2472-00</b>	<b>F48-3672-00</b>	<b>F48-4872-00</b>	<b>F48-6072-00</b>

### 6" Deep Partition Module Glass Ceiling Partition

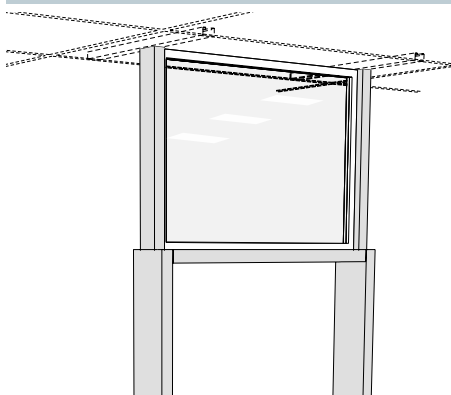

Length	12" High	18" High	24" High	30" High
24"	<b>F49G1224-00</b>	<b>F49G1824-00</b>	<b>F49G2424-00</b>	<b>F49G3024-00</b>
30"	<b>F49G1230-00</b>	<b>F49G1830-00</b>	<b>F49G2430-00</b>	<b>F49G3030-00</b>
36"	<b>F49G1236-00</b>	<b>F49G1836-00</b>	<b>F49G2436-00</b>	<b>F49G3036-00</b>
42"	<b>F49G1242-00</b>	<b>F49G1842-00</b>	<b>F49G2442-00</b>	<b>F49G3042-00</b>
48"	<b>F49G1248-00</b>	<b>F49G1848-00</b>	<b>F49G2448-00</b>	<b>F49G3048-00</b>
54"	<b>F49G1254-00</b>	<b>F49G1854-00</b>	<b>F49G2454-00</b>	<b>F49G3054-00</b>
60"	<b>F49G1260-00</b>	<b>F49G1860-00</b>	<b>F49G2460-00</b>	<b>F49G3060-00</b>
66"	<b>F49G1266-00</b>	<b>F49G1866-00</b>	<b>F49G2466-00</b>	<b>F49G3066-00</b>
72"	<b>F49G1272-00</b>	<b>F49G1872-00</b>	<b>F49G2472-00</b>	<b>F49G3072-00</b>

### 6" Deep Partition Module Solid Ceiling Partition

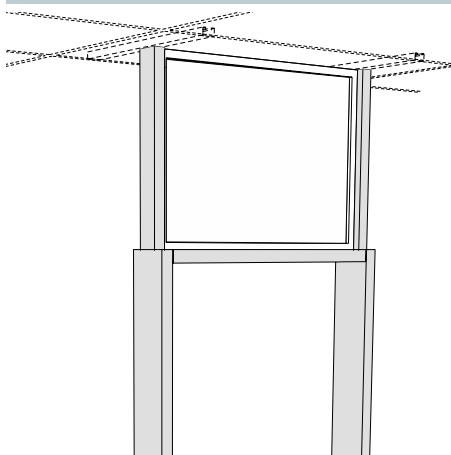

Length	12" High	18" High	24" High	30" High
24"	<b>F49M1224-00</b>	<b>F49M1824-00</b>	<b>F49M2424-00</b>	<b>F49M3024-00</b>
30"	<b>F49M1230-00</b>	<b>F49M1830-00</b>	<b>F49M2430-00</b>	<b>F49M3030-00</b>
36"	<b>F49M1236-00</b>	<b>F49M1836-00</b>	<b>F49M2436-00</b>	<b>F49M3036-00</b>
42"	<b>F49M1242-00</b>	<b>F49M1842-00</b>	<b>F49M2442-00</b>	<b>F49M3042-00</b>
48"	<b>F49M1248-00</b>	<b>F49M1848-00</b>	<b>F49M2448-00</b>	<b>F49M3048-00</b>
54"	<b>F49M1254-00</b>	<b>F49M1854-00</b>	<b>F49M2454-00</b>	<b>F49M3054-00</b>
60"	<b>F49M1260-00</b>	<b>F49M1860-00</b>	<b>F49M2460-00</b>	<b>F49M3060-00</b>
66"	<b>F49M1266-00</b>	<b>F49M1866-00</b>	<b>F49M2466-00</b>	<b>F49M3066-00</b>
72"	<b>F49M1272-00</b>	<b>F49M1872-00</b>	<b>F49M2472-00</b>	<b>F49M3072-00</b>



# 6" Corner Column Modules

**Specifications:**

Corner Column Modules allow multiple configurations of Partition Modules to form a variety of assemblies. The Column Modules are available in three heights to match the Partition Modules. Each module is furnished with removable access panels for two sides and attachment hardware.

**Module Ledge, when required must be ordered separately.**

**6" Deep Partition Module Corner Column**

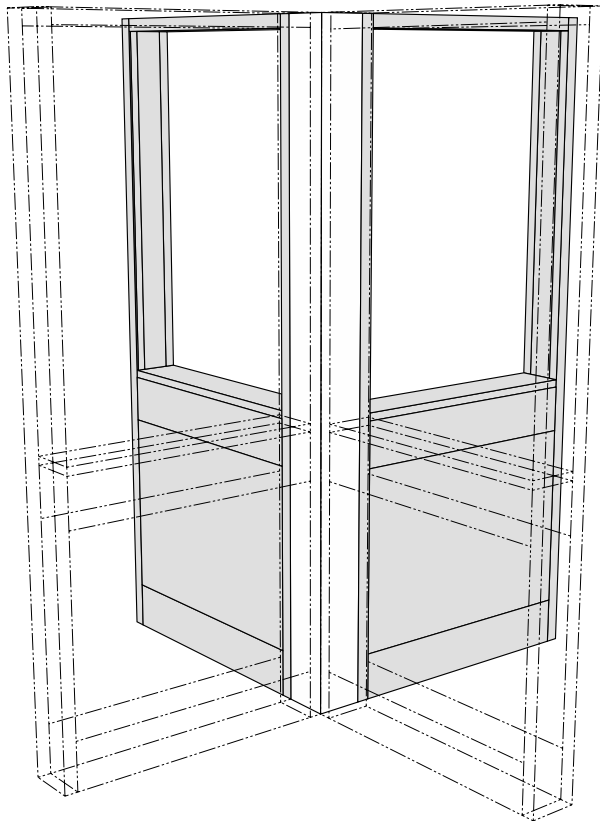

Height	Part Number
37"	<b>F40M3706-00</b>
47"	<b>F40M4706-00</b>
84"	<b>F40M8406-00</b>

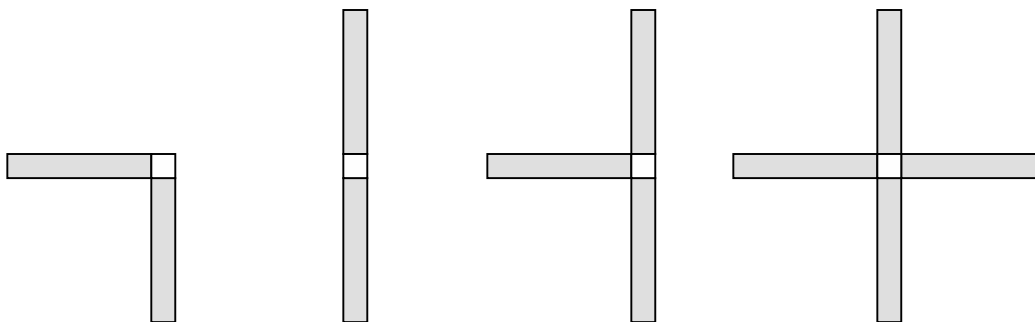

**Possible Alpha System Assembly configurations using 6" Corner Column Modules**

# 6" Partition Module End Filler

## Specifications:

Partition Module End Fillers are designed to close off the end of Partition Modules to offer a more finished appearance. A single filler is used to finish Standard Partition Modules. Two fillers are used to finish Partition Modules with Paneled Upper Carriers.

Partition Module End Fillers are provided with all required installation hardware.

## 6" Deep Partition Module End Fillers

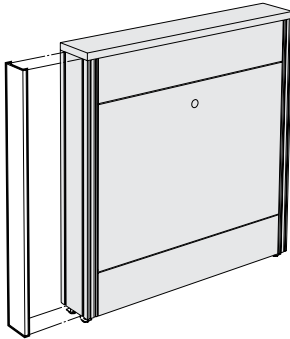

Height	Lower Filler
35"	<b>F00M0636-00</b>
45"	<b>F00M0646-00</b>

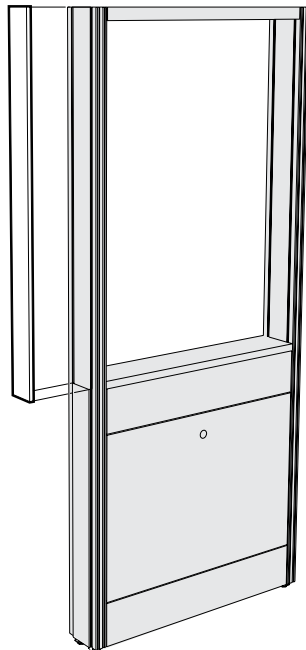

Height	Upper Filler
38"	<b>F00M0638-00</b>
48"	<b>F00M0648-00</b>

# Shelving - Worksurface & Table Frames

## Features:

- Adjustable Module Shelving
  - available in five depths
  - available in steel, wood, and phenolic resin
  - available with and without retaining lips
  - adjustable on 1" increments
  - may be mounted above or below worksurface frames
- Adjustable Core Shelving
  - infinitely height adjustable
  - available in steel only
- Adjustable Height Cantilevered Worksurface Frame
  - supports Worksurface Top and Suspended Base Cabinets
  - fabricated of 1<sup>5</sup>/<sub>8</sub>" steel channels
  - easily positioned on 1" increments
- Adjustable Height Mobile Table Frame

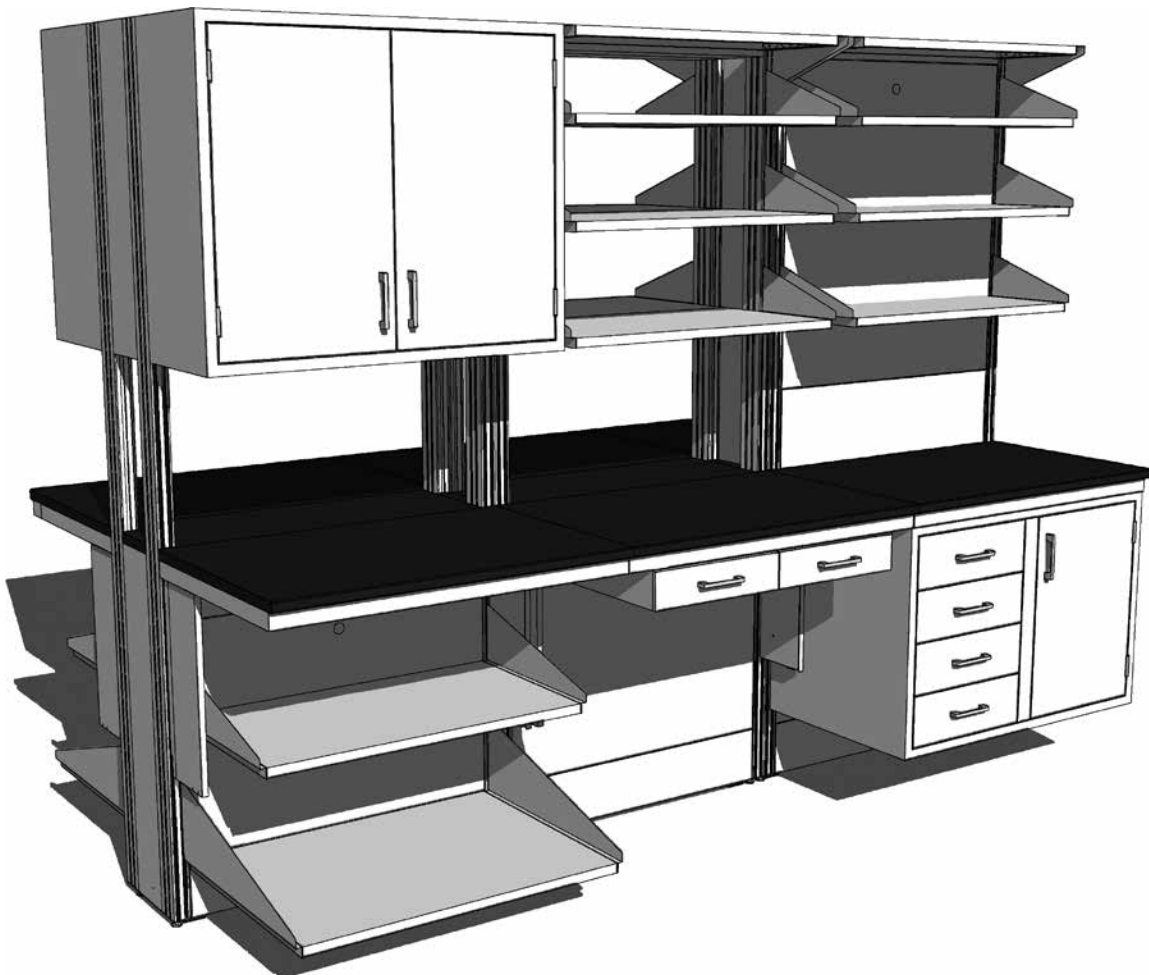

# Adjustable Module Shelving

## Specifications:

Upper Carrier Module Adjustable Core Shelves are formed of 16 gauge cold rolled steel. They are supported by four Support Clips that engage the side slots on the Module Uprights making the shelves infinitely adjustable. Available for 12" Island Module Upper Carriers only.

Adjustable Top Shelves are formed of 16 gauge cold rolled steel and are supported from below by 11 gauge steel brackets that engage the outer slot of the double slotted Structure Module Upright. Designed to be used at the top of the Module Upper Carrier.

### Upper Carrier Module Adjustable Core Shelves      Core Shelf Support Clip

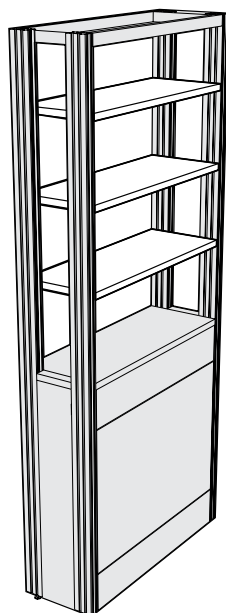

Length	Core Shelf
24"	<b>F29M1224-01</b>
30"	<b>F29M1230-01</b>
36"	<b>F29M1236-01</b>
42"	<b>F29M1242-01</b>
48"	<b>F29M1248-01</b>
54"	<b>F29M1254-01</b>
60"	<b>F29M1260-01</b>
66"	<b>F29M1266-01</b>
72"	<b>F29M1272-01</b>

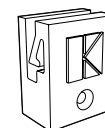

**F69-0201-00** pair

May also be used to add support to Pass-Thru Shelves. Furnished in pairs with bolt and nut to attach to side slots in Module Uprights.

Furnished standard with Upper Carrier Module Adjustable Core Shelves.

### Upper Carriers Module Adjustable Top Shelves

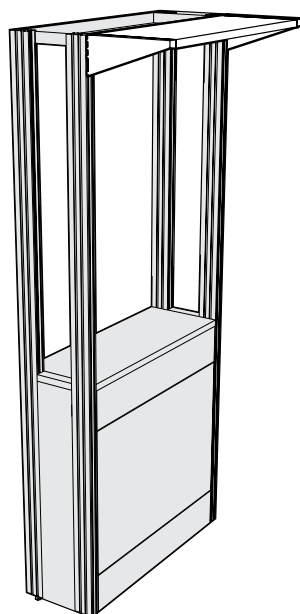

Length	12" Deep	9" Deep
24"	<b>F28M1224-00</b>	<b>F28M0924-00</b>
30"	<b>F28M1230-00</b>	<b>F28M0930-00</b>
36"	<b>F28M1236-00</b>	<b>F28M0936-00</b>
42"	<b>F28M1242-00</b>	<b>F28M0942-00</b>
48"	<b>F28M1248-00</b>	<b>F28M0948-00</b>
54"	<b>F28M1254-00</b>	<b>F28M0954-00</b>
60"	<b>F28M1260-00</b>	<b>F28M0960-00</b>
66"	<b>F28M1266-00</b>	<b>F28M0966-00</b>
72"	<b>F28M1272-00</b>	<b>F28M0972-00</b>

# Adjustable Module Shelf Assembly

## Specifications:

Adjustable Module Shelf Assemblies consist of a pair of 11 gauge steel Shelf Brackets and a Shelf. The Shelf Bracket engages the inner slot of the double slotted Structural Module Upright and is adjustable on 1" centers. Shelves are available in Painted Steel, Veneer Plywood, or Phenolic Resin.

Painted Steel Shelves – 1" thick, formed from 16 gauge cold rolled steel.

Veneer Plywood Shelves – 1" thick hardwood plywood with matching veneer on all exposed surfaces.

Phenolic Resin – 1" thick black phenolic resin.

## Open Front Adjustable Module Shelves

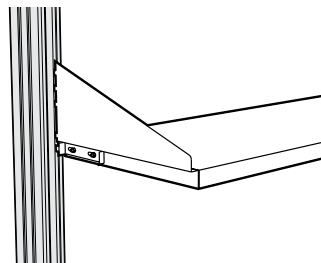
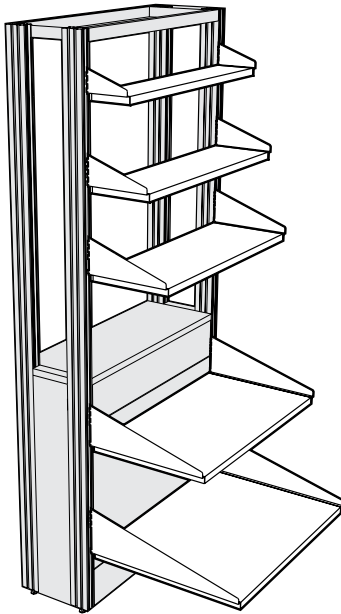

### Optional Shelf Locking Tab

Sliding tab mounted on Shelf Bracket locks Shelf into Module Upright to keep it from being accidentally removed.

To specify, add an **K** to the end of the Shelf Assembly part number.

Example: **F21M1236-00,K**

	Length	Painted Steel	Veneer Plywood	Phenolic Resin
<b>6" DEEP SHELF</b> 6" Deep Bracket	24"	<b>F21M0624-00</b>	<b>F21W0624-0_</b>	<b>F21T0624-00</b>
	30"	<b>F21M0630-00</b>	<b>F21W0630-0_</b>	<b>F21T0630-00</b>
	36"	<b>F21M0636-00</b>	<b>F21W0636-0_</b>	<b>F21T0636-00</b>
	42"	<b>F21M0642-00</b>	<b>F21W0642-0_</b>	<b>F21T0642-00</b>
	48"	<b>F21M0648-00</b>	<b>F21W0648-0_</b>	<b>F21T0648-00</b>
	54"	<b>F21M0654-00</b>		
	60"	<b>F21M0660-00</b>		
	66"	<b>F21M0666-00</b>		
<b>9" DEEP SHELF</b> 9" Deep Bracket	24"	<b>F21M0924-00</b>	<b>F21W0924-0_</b>	<b>F21T0924-00</b>
	30"	<b>F21M0930-00</b>	<b>F21W0930-0_</b>	<b>F21T0930-00</b>
	36"	<b>F21M0936-00</b>	<b>F21W0936-0_</b>	<b>F21T0936-00</b>
	42"	<b>F21M0942-00</b>	<b>F21W0942-0_</b>	<b>F21T0942-00</b>
	48"	<b>F21M0948-00</b>	<b>F21W0948-0_</b>	<b>F21T0948-00</b>
	54"	<b>F21M0954-00</b>		
	60"	<b>F21M0960-00</b>		
	66"	<b>F21M0966-00</b>		
<b>12" DEEP SHELF</b> 12" Deep Bracket	24"	<b>F21M1224-00</b>	<b>F21W1224-0_</b>	<b>F21T1224-00</b>
	30"	<b>F21M1230-00</b>	<b>F21W1230-0_</b>	<b>F21T1230-00</b>
	36"	<b>F21M1236-00</b>	<b>F21W1236-0_</b>	<b>F21T1236-00</b>
	42"	<b>F21M1242-00</b>	<b>F21W1242-0_</b>	<b>F21T1242-00</b>
	48"	<b>F21M1248-00</b>	<b>F21W1248-0_</b>	<b>F21T1248-00</b>
	54"	<b>F21M1254-00</b>		
	60"	<b>F21M1260-00</b>		
	66"	<b>F21M1266-00</b>		
<b>18" DP SHELF</b> 18" Deep Bracket	24"	<b>F21M1824-00</b>	<b>F21W1824-0_</b>	<b>F21T1824-00</b>
	30"	<b>F21M1830-00</b>	<b>F21W1830-0_</b>	<b>F21T1830-00</b>
	36"	<b>F21M1836-00</b>	<b>F21W1836-0_</b>	<b>F21T1836-00</b>
	42"	<b>F21M1842-00</b>	<b>F21W1842-0_</b>	<b>F21T1842-00</b>
	48"	<b>F21M1848-00</b>	<b>F21W1848-0_</b>	<b>F21T1848-00</b>
	60"	<b>F21M1860-00</b>		
<b>24" DP SHELF</b> 24" Deep Bracket	24"	<b>F21M2424-00</b>	<b>F21W2424-0_</b>	<b>F21T2424-00</b>
	30"	<b>F21M2430-00</b>	<b>F21W2430-0_</b>	<b>F21T2430-00</b>
	36"	<b>F21M2436-00</b>	<b>F21W2436-0_</b>	<b>F21T2436-00</b>
	42"	<b>F21M2442-00</b>	<b>F21W2442-0_</b>	<b>F21T2442-00</b>
	48"	<b>F21M2448-00</b>	<b>F21W2448-0_</b>	<b>F21T2448-00</b>
	60"	<b>F21M2460-00</b>		

To specify Veneer Plywood Species replace blank at end of part number with number that indicates material required.

### Veneer Plywood Material Options

- 1 = Red Oak
- 2 = White Maple
- 3 = Steamed Beech
- 5 = FSC® Red Oak
- 6 = FSC® White Maple
- 8 = FSC® St'md Beech

# Adjustable Pass-thru Shelf Assemblies

## Specifications:

Pass-thru Module Shelf Assemblies for 6" Partition Modules have Shelves three inches deeper than the Shelf Bracket to allow the shelf to pass through the module core and form a continuous surface. These shelves may also be moved forward and mounted to form a 2" cord gap between the shelves. Shelf Brackets are 11 gauge steel, adjustable on 1" centers.

Painted Steel Shelves – 1" thick, formed from 16 gauge cold rolled steel.

Veneer Plywood Shelves – 1" thick hardwood plywood with matching veneer on all exposed surfaces.

Phenolic Resin – 1" thick black phenolic resin.

## Adjustable Pass-thru Shelf Assemblies for 6" Partition Modules

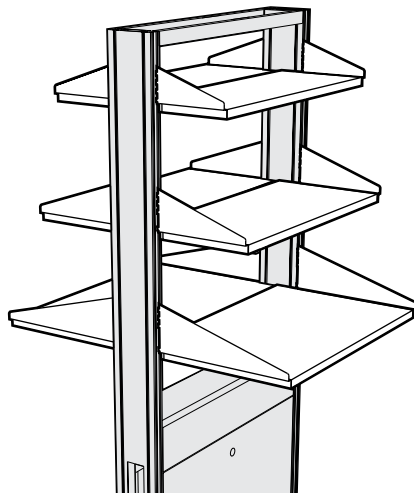

Pass-Thru Shelves

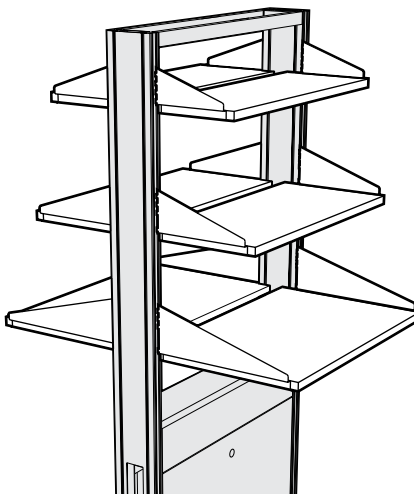

Pass-Thru Shelves with Cord Gap

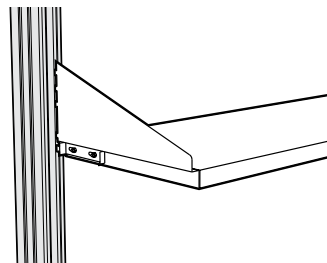

Optional Shelf Locking Tab

	Length	Painted Steel	Veneer Plywood	Phenolic Resin
<b>9" DEEP SHELF</b> 6" Deep Bracket	24"	<b>F21M0624-30</b>	<b>F21W0624-3_</b>	<b>F21T0624-30</b>
	30"	<b>F21M0630-30</b>	<b>F21W0630-3_</b>	<b>F21T0630-30</b>
	36"	<b>F21M0636-30</b>	<b>F21W0636-3_</b>	<b>F21T0636-30</b>
	42"	<b>F21M0642-30</b>	<b>F21W0642-3_</b>	<b>F21T0642-30</b>
	48"	<b>F21M0648-30</b>	<b>F21W0648-3_</b>	<b>F21T0648-30</b>
	54"	<b>F21M0654-30</b>		
	60"	<b>F21M0660-30</b>		
	66"	<b>F21M0666-30</b>		
<b>12" DEEP SHELF</b> 9" Deep Bracket	24"	<b>F21M0924-30</b>	<b>F21W0924-3_</b>	<b>F21T0924-30</b>
	30"	<b>F21M0930-30</b>	<b>F21W0930-3_</b>	<b>F21T0930-30</b>
	36"	<b>F21M0936-30</b>	<b>F21W0936-3_</b>	<b>F21T0936-30</b>
	42"	<b>F21M0942-30</b>	<b>F21W0942-3_</b>	<b>F21T0942-30</b>
	48"	<b>F21M0948-30</b>	<b>F21W0948-3_</b>	<b>F21T0948-30</b>
	54"	<b>F21M0954-30</b>		
	60"	<b>F21M0960-30</b>		
	66"	<b>F21M0966-30</b>		
<b>15" DEEP SHELF</b> 12" Deep Bracket	24"	<b>F21M1224-30</b>	<b>F21W1224-3_</b>	<b>F21T1224-30</b>
	30"	<b>F21M1230-30</b>	<b>F21W1230-3_</b>	<b>F21T1230-30</b>
	36"	<b>F21M1236-30</b>	<b>F21W1236-3_</b>	<b>F21T1236-30</b>
	42"	<b>F21M1242-30</b>	<b>F21W1242-3_</b>	<b>F21T1242-30</b>
	48"	<b>F21M1248-30</b>	<b>F21W1248-3_</b>	<b>F21T1248-30</b>
	54"	<b>F21M1254-30</b>		
	60"	<b>F21M1260-30</b>		
	66"	<b>F21M1266-30</b>		
<b>21" DEEP SHELF</b> 18" Deep Bracket	24"	<b>F21M1824-30</b>	<b>F21W1824-3_</b>	<b>F21T1824-30</b>
	30"	<b>F21M1830-30</b>	<b>F21W1830-3_</b>	<b>F21T1830-30</b>
	36"	<b>F21M1836-30</b>	<b>F21W1836-3_</b>	<b>F21T1836-30</b>
	42"	<b>F21M1842-30</b>	<b>F21W1842-3_</b>	<b>F21T1842-30</b>
	48"	<b>F21M1848-30</b>	<b>F21W1848-3_</b>	<b>F21T1848-30</b>
	54"	<b>F21M1854-30</b>		
60"	<b>F21M1860-30</b>			

To specify Veneer Plywood Species replace blank at end of part number with number that indicates material required.

### Veneer Plywood Material Options

- 1 = Red Oak
- 2 = White Maple
- 7 = Steamed Beech
- 5 = FSC® Red Oak
- 6 = FSC® White Maple
- 8 = FSC® St'md Beech

### Optional Shelf Locking Tab

Sliding tab mounted on Shelf Bracket locks Shelf into Module Upright to keep it from being accidentally removed.

To specify, add an **K** to the end of the Shelf Assembly part number. Example: **F21M1236-00,K**

# Adjustable Pass-thru Shelf Assemblies

**Specifications:**  
 Pass-thru Shelf Assemblies for 12" Island Modules are six inches deeper than the Shelf Bracket to allow the Shelf to pass through the module core and form a continuous surface. These shelves may also be moved forward and mounted to form a 2" cord gap between the shelves. Shelf Brackets are 11 gauge steel, adjustable on 1" centers.

Painted Steel Shelves – 1" thick, formed from 16 gauge cold rolled steel.

Veneer Plywood Shelves – 1" thick hardwood plywood with matching veneer on all exposed surfaces.

Phenolic Resin – 1" thick phenolic resin.

## Adjustable Pass-thru Shelf Assemblies for 12" Island Modules

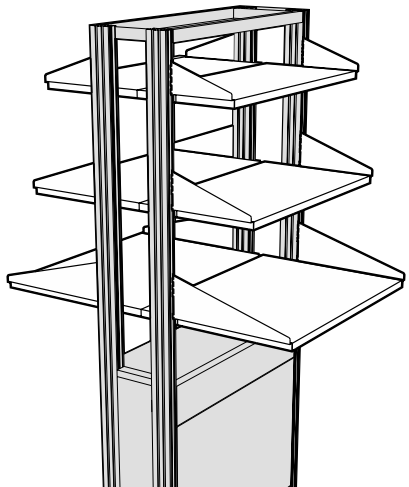

Pass-Thru Shelves

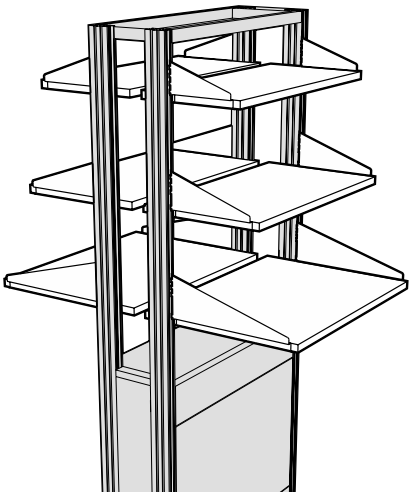

Pass-Thru Shelves with Cord Gap

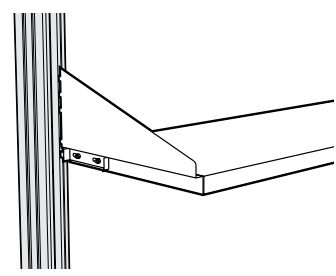

Optional Shelf Locking Tab

	Length	Painted Steel	Veneer Plywood	Phenolic Resin
<b>15" DEEP SHELF</b> 9" Deep Bracket	24"	<b>F21M0924-60</b>	<b>F21W0924-6_</b>	<b>F21T0924-60</b>
	30"	<b>F21M0930-60</b>	<b>F21W0930-6_</b>	<b>F21T0930-60</b>
	36"	<b>F21M0936-60</b>	<b>F21W0936-6_</b>	<b>F21T0936-60</b>
	42"	<b>F21M0942-60</b>	<b>F21W0942-6_</b>	<b>F21T0942-60</b>
	48"	<b>F21M0948-60</b>	<b>F21W0948-6_</b>	<b>F21T0948-60</b>
	54"	<b>F21M0954-60</b>		
	60"	<b>F21M0960-60</b>		
	66"	<b>F21M0966-60</b>		
	72"	<b>F21M0972-60</b>		
<b>18" DEEP SHELF</b> 12" Deep Bracket	24"	<b>F21M1224-60</b>	<b>F21W1224-6_</b>	<b>F21T1224-60</b>
	30"	<b>F21M1230-60</b>	<b>F21W1230-6_</b>	<b>F21T1230-60</b>
	36"	<b>F21M1236-60</b>	<b>F21W1236-6_</b>	<b>F21T1236-60</b>
	42"	<b>F21M1242-60</b>	<b>F21W1242-6_</b>	<b>F21T1242-60</b>
	48"	<b>F21M1248-60</b>	<b>F21W1248-6_</b>	<b>F21T1248-60</b>
	54"	<b>F21M1254-60</b>		
	60"	<b>F21M1260-60</b>		
	66"	<b>F21M1266-60</b>		
	72"	<b>F21M1272-60</b>		
<b>24" DEEP SHELF</b> 18" Deep Bracket	24"	<b>F21M1824-60</b>	<b>F21W1824-6_</b>	<b>F21T1824-60</b>
	30"	<b>F21M1830-60</b>	<b>F21W1830-6_</b>	<b>F21T1830-60</b>
	36"	<b>F21M1836-60</b>	<b>F21W1836-6_</b>	<b>F21T1836-60</b>
	42"	<b>F21M1842-60</b>	<b>F21W1842-6_</b>	<b>F21T1842-60</b>
	48"	<b>F21M1848-60</b>	<b>F21W1848-6_</b>	<b>F21T1848-60</b>
	54"	<b>F21M1854-60</b>		
	60"	<b>F21M1860-60</b>		

To specify Veneer Plywood Species replace blank at end of part number with number that indicates material required.

- Veneer Plywood Material Options**
- 1 = Red Oak
  - 2 = White Maple
  - 7 = Steamed Beech
  - 5 = FSC® Red Oak
  - 6 = FSC® White Maple
  - 8 = FSC® St'md Beech

**Optional Shelf Locking Tab**

Sliding tab mounted on Shelf Bracket locks Shelf into Module Upright to keep it from being accidentally removed.

To specify, add an **K** to the end of the Shelf Assembly part number.  
 Example: **F21M1236-00,K**

# Module Shelves

### Specifications:

Module Shelves are available without Shelf Brackets for custom applications and for replacement. These are the same Shelves that are furnished with Adjustable Module and Pass-Thru Shelf Assemblies except they are not furnished with Shelf Brackets or attachment hardware.

Painted Steel Shelves – 1" thick, formed from 16 gauge cold rolled steel.

Plywood Veneer Shelves – 1" thick hardwood plywood with matching veneer on all exposed surfaces.

Phenolic Resin – 1" thick black phenolic resin.

Shelf Brackets are available separately.

**Actual Shelf Length 3<sup>3</sup>/<sub>8</sub>" less than Module Length**

### Module Shelves without Shelf Brackets

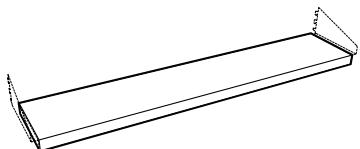
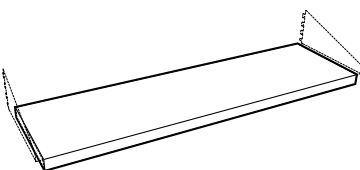
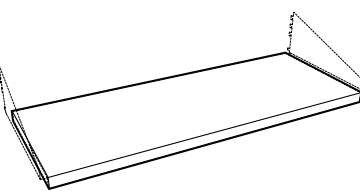
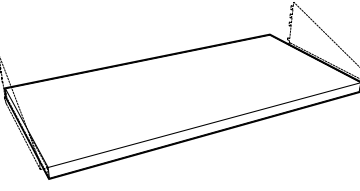
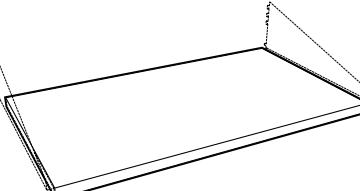
	Module Length	<i>(actual shelf length 3<sup>1</sup>/<sub>2</sub>" less than module length)</i>		
		Painted Steel	Plywood Veneer	Phenolic Resin
	24"	<b>F24M0624-00</b>	<b>F24W0624-0</b>	<b>F24T0624-00</b>
	30"	<b>F24M0630-00</b>	<b>F24W0630-0</b>	<b>F24T0630-00</b>
	36"	<b>F24M0636-00</b>	<b>F24W0636-0</b>	<b>F24T0636-00</b>
	42"	<b>F24M0642-00</b>	<b>F24W0642-0</b>	<b>F24T0642-00</b>
	48"	<b>F24M0648-00</b>	<b>F24W0648-0</b>	<b>F24T0648-00</b>
	54"	<b>F24M0654-00</b>		
	60"	<b>F24M0660-00</b>		
	72"	<b>F24M0672-00</b>		
	24"	<b>F24M0924-00</b>	<b>F24W0924-0</b>	<b>F24T0924-00</b>
	30"	<b>F24M0930-00</b>	<b>F24W0930-0</b>	<b>F24T0930-00</b>
	36"	<b>F24M0936-00</b>	<b>F24W0936-0</b>	<b>F24T0936-00</b>
	42"	<b>F24M0942-00</b>	<b>F24W0942-0</b>	<b>F24T0942-00</b>
	48"	<b>F24M0948-00</b>	<b>F24W0948-0</b>	<b>F24T0948-00</b>
	54"	<b>F24M0954-00</b>		
	60"	<b>F24M0960-00</b>		
	72"	<b>F24M0972-00</b>		
	24"	<b>F24M1224-00</b>	<b>F24W1224-0</b>	<b>F24T1224-00</b>
	30"	<b>F24M1230-00</b>	<b>F24W1230-0</b>	<b>F24T1230-00</b>
	36"	<b>F24M1236-00</b>	<b>F24W1236-0</b>	<b>F24T1236-00</b>
	42"	<b>F24M1242-00</b>	<b>F24W1242-0</b>	<b>F24T1242-00</b>
	48"	<b>F24M1248-00</b>	<b>F24W1248-0</b>	<b>F24T1248-00</b>
	54"	<b>F24M1254-00</b>		
	60"	<b>F24M1260-00</b>		
	72"	<b>F24M1272-00</b>		
	24"	<b>F24M1524-00</b>	<b>F24W1524-0</b>	<b>F24T1524-00</b>
	30"	<b>F24M1530-00</b>	<b>F24W1530-0</b>	<b>F24T1530-00</b>
	36"	<b>F24M1536-00</b>	<b>F24W1536-0</b>	<b>F24T1536-00</b>
	42"	<b>F24M1542-00</b>	<b>F24W1542-0</b>	<b>F24T1542-00</b>
	48"	<b>F24M1548-00</b>	<b>F24W1548-0</b>	<b>F24T1548-00</b>
	60"	<b>F24M1560-00</b>		
	24"	<b>F24M1824-00</b>	<b>F24W1824-0</b>	<b>F24T1824-00</b>
	30"	<b>F24M1830-00</b>	<b>F24W1830-0</b>	<b>F24T1830-00</b>
	36"	<b>F24M1836-00</b>	<b>F24W1836-0</b>	<b>F24T1836-00</b>
	42"	<b>F24M1842-00</b>	<b>F24W1842-0</b>	<b>F24T1842-00</b>
	48"	<b>F24M1848-00</b>	<b>F24W1848-0</b>	<b>F24T1848-00</b>
	60"	<b>F24M1860-00</b>		

To specify Veneer Plywood Species replace blank at end of part number with number that indicates material required.

**Veneer Plywood Material Options**

- 1 = Red Oak                      -5 = FSC® Red Oak
- 2 = White Maple                -6 = FSC® White Maple
- 7 = Steamed Beech              -8 = FSC® St'md Beech



# Module Shelves & Shelf Brackets

## Specifications:

Module Shelves are available without Shelf Brackets for custom applications and for replacement. These are the same Shelves that are furnished with Adjustable Module and Pass-Thru Shelf Assemblies except they are not furnished with Shelf Brackets or attachment hardware.

Painted Steel Shelves – 1" thick, formed from 16 gauge cold rolled steel.

Plywood Veneer Shelves – 1" thick hardwood plywood with matching veneer on all exposed surfaces.

Phenolic Resin – 1" thick black phenolic resin.

**Shelf Brackets are available separately.**

## Module Shelves without Shelf Brackets

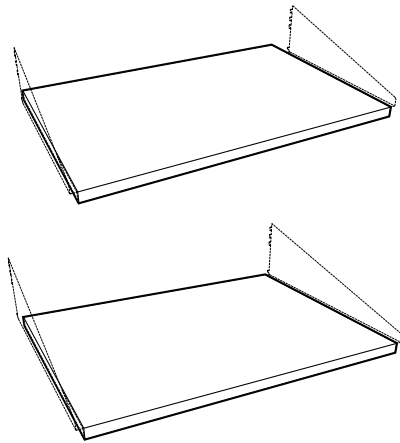

	Module Length	<i>(actual shelf length 3½" less than module length)</i>		
		Painted Steel	Plywood Veneer	Phenolic Resin
<b>21" DEEP</b>	24"	<b>F24M2124-00</b>	<b>F24W2124-0_</b>	<b>F24T2124-00</b>
	30"	<b>F24M2130-00</b>	<b>F24W2130-0_</b>	<b>F24T2130-00</b>
	36"	<b>F24M2136-00</b>	<b>F24W2136-0_</b>	<b>F24T2136-00</b>
	42"	<b>F24M2142-00</b>	<b>F24W2142-0_</b>	<b>F24T2142-00</b>
	48"	<b>F24M2148-00</b>	<b>F24W2148-0_</b>	<b>F24T2148-00</b>
	60"	<b>F24M2160-00</b>		
<b>24" DEEP</b>	24"	<b>F24M2424-00</b>	<b>F24W2424-0_</b>	<b>F24T2424-00</b>
	30"	<b>F24M2430-00</b>	<b>F24W2430-0_</b>	<b>F24T2430-00</b>
	36"	<b>F24M2436-00</b>	<b>F24W2436-0_</b>	<b>F24T2436-00</b>
	42"	<b>F24M2442-00</b>	<b>F24W2442-0_</b>	<b>F24T2442-00</b>
	48"	<b>F24M2448-00</b>	<b>F24W2448-0_</b>	<b>F24T2448-00</b>
	60"	<b>F24M2460-00</b>		

To specify Veneer Plywood Species replace blank at end of part number with number that indicates material required.

### Veneer Plywood Material Options

- 1 = Red Oak                      -5 = FSC® Red Oak
- 2 = White Maple                -6 = FSC® White Maple
- 7 = Steamed Beech              -8 = FSC® St'md Beech

## Shelf Brackets for Steel Shelves (in pairs)

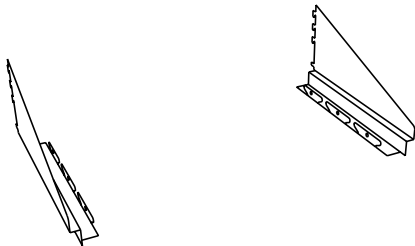

Depth	Shelf Brackets w/o Locking Tabs	Shelf Brackets with Locking Tabs	
6"	<b>F20M0306-00</b>	<b>F20M0306-00K</b>	pair
9"	<b>F20M0409-00</b>	<b>F20M0409-00K</b>	pair
12"	<b>F20M0512-00</b>	<b>F20M0512-00K</b>	pair
18"	<b>F20M0618-00</b>	<b>F20M0618-00K</b>	pair
24"	<b>F20M0724-00</b>	<b>F20M0724-00K</b>	pair

## Shelf Brackets for Wood & Phenolic Resin Shelves (in pairs)

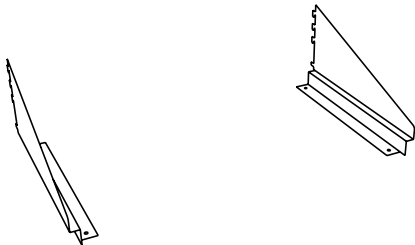

Depth	Shelf Brackets w/o Locking Tabs	Shelf Brackets with Locking Tabs	
6"	<b>F20-0306-00</b>	<b>F20-0306-00K</b>	pair
9"	<b>F20-0409-00</b>	<b>F20-0409-00K</b>	pair
12"	<b>F20-0512-00</b>	<b>F20-0512-00K</b>	pair
18"	<b>F20-0618-00</b>	<b>F20-0618-00K</b>	pair
24"	<b>F20-0724-00</b>	<b>F20-0724-00K</b>	pair

# Shelves Retaining Lips & Light Fixtures

## Specifications:

Shelf Retaining Lips are designed to be added to Adjustable Core Shelves, Module Shelves, Adjustable Module Shelf Assemblies, and Adjustable Pass-Thru Shelf Assemblies. Steel Shelf Lips may be mounted to steel, wood or phenolic resin shelves with supplied screws.

Under Cabinet Light Fixtures are thin-profile, specification grade, with white, painted steel housing, 1" high by 3½" deep in lengths shown. UL listed and furnished with rocker switch, single outlet, lamp, and six foot cord.

## Shelf Retaining Lips

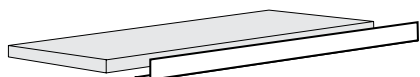

Designed to be added to Adjustable Core Shelves, Module Shelves, Adjustable Module Shelf Assemblies, and Adjustable Pass-Thru Shelf Assemblies. Steel Shelf Lips may be mounted to steel, wood or phenolic resin shelves with supplied screws.

Length	Shelf Lip	
24"	<b>F63M0224-00</b>	each
30"	<b>F63M0230-00</b>	each
36"	<b>F63M0236-00</b>	each
42"	<b>F63M0242-00</b>	each
48"	<b>F63M0248-00</b>	each
54"	<b>F63M0254-00</b>	each
60"	<b>F63M0260-00</b>	each
66"	<b>F63M0266-00</b>	each
72"	<b>F63M0272-00</b>	each

## Task Lighting

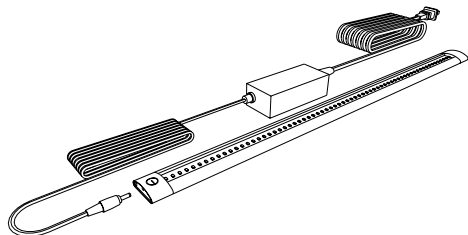

Part Number	Length
<b>X-030001-00</b>	300mm – 11 <sup>7</sup> / <sub>8</sub> "
<b>X-030002-00</b>	500mm – 19 <sup>5</sup> / <sub>8</sub> "
<b>X-030003-00</b>	1000mm – 39 <sup>3</sup> / <sub>8</sub> "

**LED Task Lighting** consists of a thin-profile, white, LED strip, 9.5mm high by 33mm deep with a touch dimmer switch. It is UL listed and furnished with 120 VAC to 24 VDC power supply with ten foot power cord. The light includes a magnetic mounting strip for mounting to steel shelving and integral tabs for mounting to wood and plastic laminate.

## Shelving Uprights

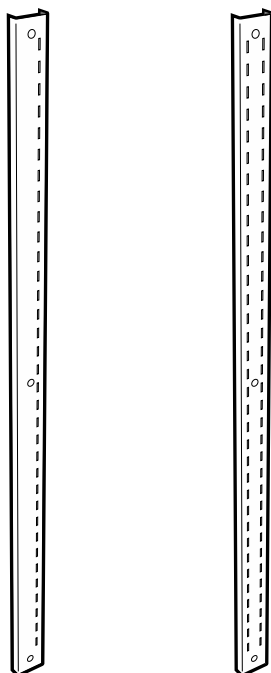

### Painted Steel Uprights

Length	Single Slot Upright	Double Slot Upright	
24"	<b>F13M000224-00</b>	<b>F12M000224-00</b>	each
30"	<b>F13M000230-00</b>	<b>F12M000230-00</b>	each
36"	<b>F13M000236-00</b>	<b>F12M000236-00</b>	each
42"	<b>F13M000242-00</b>	<b>F12M000242-00</b>	each
48"	<b>F13M000248-00</b>	<b>F12M000248-00</b>	each
72"	<b>F13M000272-00</b>	<b>F12M000272-00</b>	each
79"	<b>F13M000279-00</b>	<b>F12M000279-00</b>	each
84"	<b>F13M000284-00</b>	<b>F12M000284-00</b>	each

### Stainless Steel Uprights

Length	Single Slot Upright	Double Slot Upright	
24"	<b>F13S000224-00</b>	<b>F12S000224-00</b>	each
30"	<b>F13S000230-00</b>	<b>F12S000230-00</b>	each
36"	<b>F13S000236-00</b>	<b>F12S000236-00</b>	each
42"	<b>F13S000242-00</b>	<b>F12S000242-00</b>	each
48"	<b>F13S000248-00</b>	<b>F12S000248-00</b>	each
72"	<b>F13S000272-00</b>	<b>F12S000272-00</b>	each
79"	<b>F13S000279-00</b>	<b>F12S000279-00</b>	each
84"	<b>F13S000284-00</b>	<b>F12S000284-00</b>	each

Designed to be used with Adjustable Module Shelving Assemblies to create wall mounted shelving.

# Adjustable Height Worksurface Frames

**Specifications:**

Adjustable Height Cantilevered Worksurface Frames engage the outer slot of the double slotted Structural Module Upright and adjusts in height on 1" increments. Fabricated from steel channels and an 11 gauge steel hanging bracket.

The Optional Adjustable Height Support Legs may be added to any Worksurface Frame to add strength. Fabricated from aluminum tubing with an adjustable glide at the bottom of the leg, they may be added or removed as required

**Worksurface Top must be ordered separately.**

**Adjustable Height Cantilevered Worksurface Frame – 23¼" Deep**

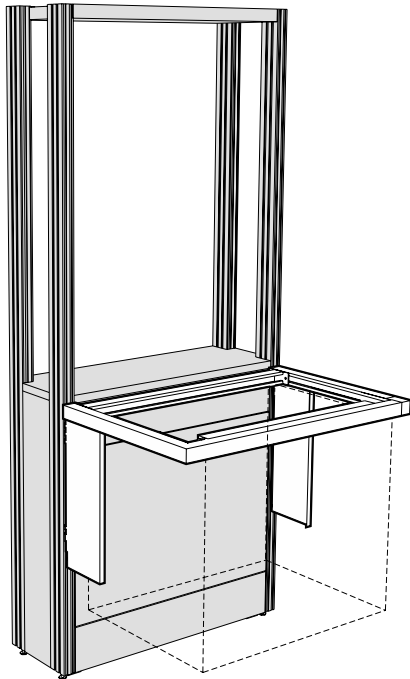

Length	23¼" Deep Frame
24"	<b>F80-2324-00</b>
30"	<b>F80-2330-00</b>
36"	<b>F80-2336-00</b>
42"	<b>F80-2342-00</b>
48"	<b>F80-2348-00</b>
54"	<b>F80-2354-00</b>
60"	<b>F80-2360-00</b>
66"	<b>F80-2366-00</b>
72"	<b>F80-2372-00</b>

# Adjustable Height Worksurface Frames

## Specifications:

Adjustable Height Cantilevered Worksurface Frames engage the outer slot of the double slotted Structural Module Upright and adjusts in height on 1" increments. Fabricated from steel channels and an 11 gauge steel hanging bracket.

The Optional Adjustable Height Support Legs may be added to any Worksurface Frame to add strength. Fabricated from aluminum tubing with an adjustable glide at the bottom of the leg, they may be added or removed as required.

**Worksurface Top must be ordered separately.**

## Adjustable Height Cantilevered Worksurface Frame – 29¼" Deep

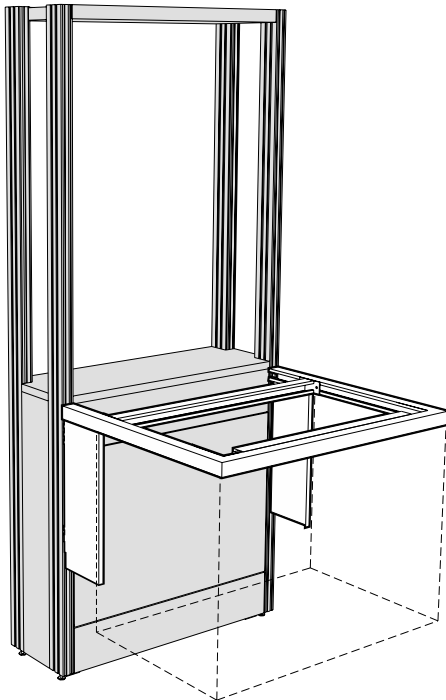

Length	29¼" Deep Frame
24"	<b>F80-2924-00</b>
30"	<b>F80-2930-00</b>
36"	<b>F80-2936-00</b>
42"	<b>F80-2942-00</b>
48"	<b>F80-2948-00</b>
54"	<b>F80-2954-00</b>
60"	<b>F80-2960-00</b>
66"	<b>F80-2966-00</b>
72"	<b>F80-2972-00</b>

# Adjustable Height Worksurface Frames

## Specifications:

Adjustable Height Cantilevered Corner Worksurface Frame, same as standard Worksurface Frame except designed to be used when two Structural Modules meet to form an inside corner. Frame supports Worksurface Top and can also support a Suspended Cabinet mounted 45 degrees to the module.

The Corner Worksurface Frame Filler may be used to fill the space below the Corner Worksurface Frame when a suspended base cabinet is not used. The filler is fabricated from cold rolled steel and is finished to match the frame.

**Worksurface Top must be ordered separately.**

## Adjustable Height Cantilevered Corner Worksurface Frame

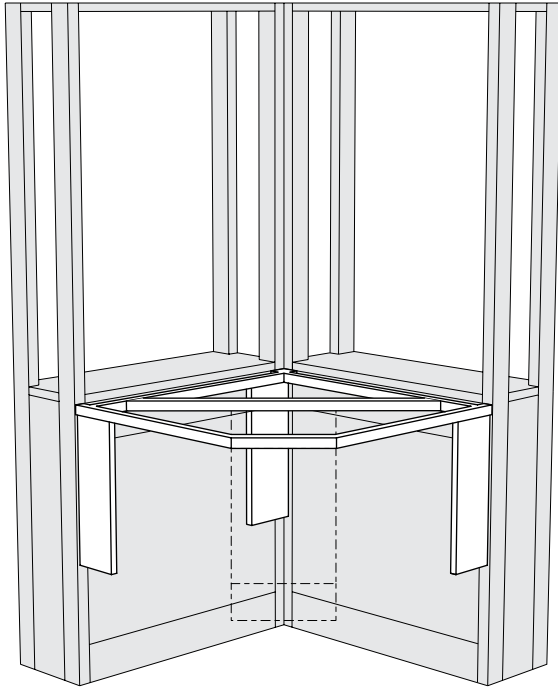

Module Length	23" Deep Frame	Maximum Cabinet Size
36"	<b>F81-2336-00</b>	18" L
42"	<b>F81-2342-00</b>	24" L
48"	<b>F81-2348-00</b>	30" L
Module Length	29" Deep Frame	Maximum Cabinet Size
36"	<b>F81-2936-00</b>	n/a
42"	<b>F81-2942-00</b>	18" L
48"	<b>F81-2948-00</b>	24" L

## Corner Worksurface Frame Filler

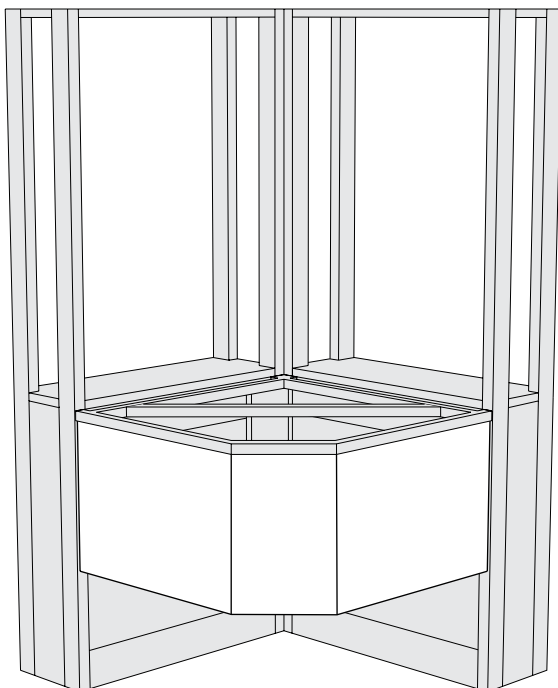

Module Length	23" Deep Frame	29" Deep Frame
36"	<b>F82M2336-00</b>	<b>F82M2936-00</b>
42"	<b>F82M2342-00</b>	<b>F82M2942-00</b>
48"	<b>F82M2348-00</b>	<b>F82M2948-00</b>

# Worksurface & Module Tops

**Features:**

- Module Ledges and Worksurface Tops available in three laboratory proven materials:
  - Kewaunee Kemresin®
  - Phenolic Resin
  - High Pressure Laminate
- Module Ledges and Worksurface Tops available in all Module and Worksurface Frame sizes.
- Modular Worksurface Tops available with 1" wide "Cord Gaps".
- Custom cutout and fixture hole arrangements available.
- Custom Worksurface Top sizes and styles available.

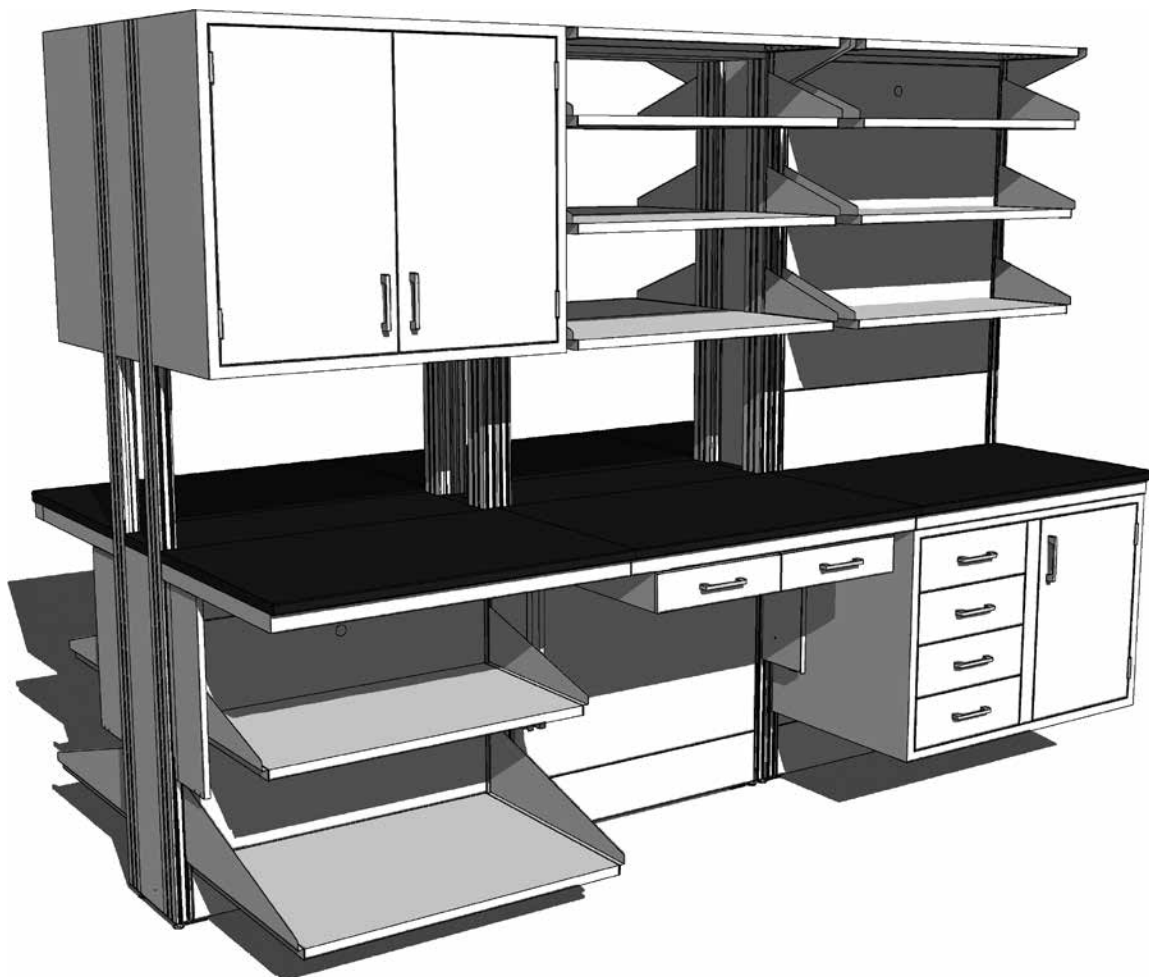

# Module Ledges

## Specifications:

Module Ledges are required to cover the open top of Wall and Island Structural Modules. They are 1" thick with all edges finished square and are most commonly ordered in the same material and color as the Worksurface Tops, but it is not required.

**F92** Module Ledges are designed for use on Modules without Upper Carriers and match the Module length.

**F90** Module Ledges are for use on Modules with Upper Carriers, and are 3 1/4" less in length than the Module.

### 3" Deep Module Ledges for 37" & 47" High Wall Modules

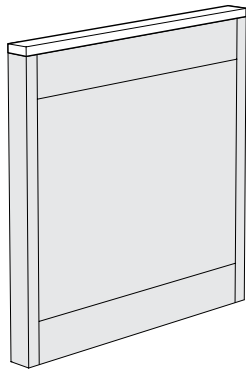

Length	Kemresin®	Phenolic Resin	High Pressure Laminate
24"	<b>F92R0324-00</b>	<b>F92T0324-00</b>	<b>F92P0324-00</b>
30"	<b>F92R0330-00</b>	<b>F92T0330-00</b>	<b>F92P0330-00</b>
36"	<b>F92R0336-00</b>	<b>F92T0336-00</b>	<b>F92P0336-00</b>
42"	<b>F92R0342-00</b>	<b>F92T0342-00</b>	<b>F92P0342-00</b>
48"	<b>F92R0348-00</b>	<b>F92T0348-00</b>	<b>F92P0348-00</b>
54"	<b>F92R0354-00</b>	<b>F92T0354-00</b>	<b>F92P0354-00</b>
60"	<b>F92R0360-00</b>	<b>F92T0360-00</b>	<b>F92P0360-00</b>
66"	<b>F92R0366-00</b>	<b>F92T0366-00</b>	<b>F92P0366-00</b>
72"	<b>F92R0372-00</b>	<b>F92T0372-00</b>	<b>F92P0372-00</b>

### 3" Deep Module Ledges for 84" High Wall Modules with Upper Carriers

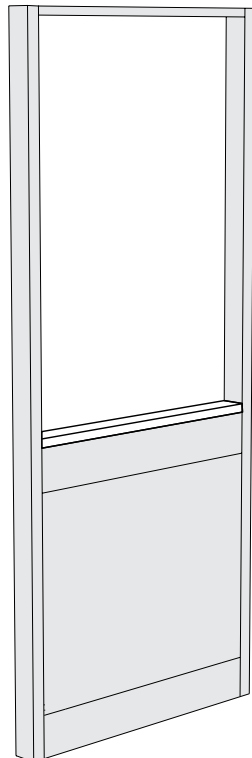

Length	Kemresin®	Phenolic Resin	High Pressure Laminate
24"	<b>F90R0324-00</b>	<b>F90T0324-00</b>	<b>F90P0324-00</b>
30"	<b>F90R0330-00</b>	<b>F90T0330-00</b>	<b>F90P0330-00</b>
36"	<b>F90R0336-00</b>	<b>F90T0336-00</b>	<b>F90P0336-00</b>
42"	<b>F90R0342-00</b>	<b>F90T0342-00</b>	<b>F90P0342-00</b>
48"	<b>F90R0348-00</b>	<b>F90T0348-00</b>	<b>F90P0348-00</b>
54"	<b>F90R0354-00</b>	<b>F90T0354-00</b>	<b>F90P0354-00</b>
60"	<b>F90R0360-00</b>	<b>F90T0360-00</b>	<b>F90P0360-00</b>
66"	<b>F90R0366-00</b>	<b>F90T0366-00</b>	<b>F90P0366-00</b>
72"	<b>F90R0372-00</b>	<b>F90T0372-00</b>	<b>F90P0372-00</b>

#### Color Option Code

##### Kemresin

**BK** = Black      **GR** = Grey      **PT**=Putty      **SL** = Slate

Kemresin is available in four standard colors. To specify Kemresin color, place a dash and the two-letter code at the end of the part number.

**Example:** F92R0324-00-**BK** for Black

If no color is specified, Kemresin will be furnished in Black.

##### Phenolic Resin - High Pressure Laminate

Phenolic Resin and High Pressure Laminate is furnished in Black standard.

# Module Ledges

## Specifications:

Module Ledges are required to cover the open top of Wall and Island Structural Modules. They are 1" thick with all edges finished square and are most commonly ordered in the same material and color as the Worksurface Tops, but it is not required.

**F92** Module Ledges are designed for use on Modules without Upper Carriers and match the Module length.

**F90** Module Ledges are for use on Modules with Upper Carriers, and are 3 1/4" less in length than the Module.

### 9" Deep Module Ledges for 37" & 47" High Wall Modules

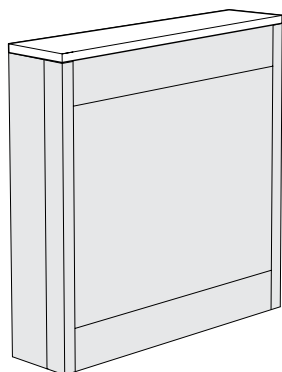

Length	Kemresin®	Phenolic Resin	High Pressure Laminate
24"	<b>F92R0924-00</b>	<b>F92T0924-00</b>	<b>F92P0924-00</b>
30"	<b>F92R0930-00</b>	<b>F92T0930-00</b>	<b>F92P0930-00</b>
36"	<b>F92R0936-00</b>	<b>F92T0936-00</b>	<b>F92P0936-00</b>
42"	<b>F92R0942-00</b>	<b>F92T0942-00</b>	<b>F92P0942-00</b>
48"	<b>F92R0948-00</b>	<b>F92T0948-00</b>	<b>F92P0948-00</b>
54"	<b>F92R0954-00</b>	<b>F92T0954-00</b>	<b>F92P0954-00</b>
60"	<b>F92R0960-00</b>	<b>F92T0960-00</b>	<b>F92P0960-00</b>
66"	<b>F92R0966-00</b>	<b>F92T0966-00</b>	<b>F92P0966-00</b>
72"	<b>F92R0972-00</b>	<b>F92T0972-00</b>	<b>F92P0972-00</b>

### 9" Deep Module Ledges for 84" High Wall Modules with Upper Carriers

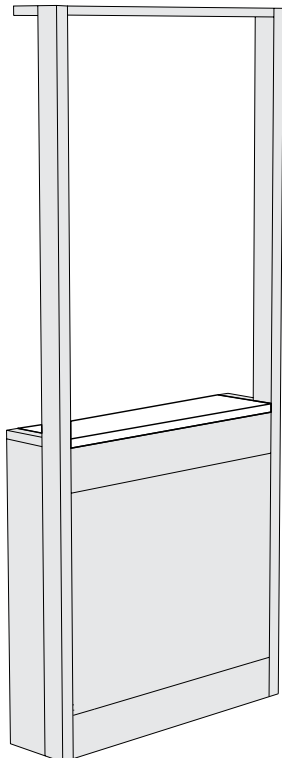

Length	Kemresin®	Phenolic Resin	High Pressure Laminate
24"	<b>F90R0924-00</b>	<b>F90T0924-00</b>	<b>F90P0924-00</b>
30"	<b>F90R0930-00</b>	<b>F90T0930-00</b>	<b>F90P0930-00</b>
36"	<b>F90R0936-00</b>	<b>F90T0936-00</b>	<b>F90P0936-00</b>
42"	<b>F90R0942-00</b>	<b>F90T0942-00</b>	<b>F90P0942-00</b>
48"	<b>F90R0948-00</b>	<b>F90T0948-00</b>	<b>F90P0948-00</b>
54"	<b>F90R0954-00</b>	<b>F90T0954-00</b>	<b>F90P0954-00</b>
60"	<b>F90R0960-00</b>	<b>F90T0960-00</b>	<b>F90P0960-00</b>
66"	<b>F90R0966-00</b>	<b>F90T0966-00</b>	<b>F90P0966-00</b>
72"	<b>F90R0972-00</b>	<b>F90T0972-00</b>	<b>F90P0972-00</b>

#### Module End Caps

Depth	Kemresin®	Phenolic Resin	High Pressure Laminate
6"	<b>F91R0206-00</b>	<b>F91T0206-00</b>	<b>F91P0206-00</b>

#### Color Option Code

##### Kemresin

**BK** = Black      **GR** = Grey      **PT** = Putty      **SL** = Slate

Kemresin is available in four standard colors. To specify Kemresin color, place a dash and the two-letter code at the end of the part number.

**Example:** F92R0924-00-**BK** for Black

If no color is specified, Kemresin will be furnished in Black.

##### Phenolic Resin - High Pressure Laminate

Phenolic Resin and High Pressure Laminate is furnished in Black standard.



# Module Ledges

## Specifications:

Module Ledges are required to cover the open top of Wall and Island Structural Modules. They are 1" thick with all edges finished square and are most commonly ordered in the same material and color as the Worksurface Tops, but it is not required.

**F92** Module Ledges are designed for use on Modules without Upper Carriers and match the Module length.

**F90** Module Ledges are for use on Modules with Upper Carriers, and are 3 1/4" less in length than the Module.

### 12" Deep Module Ledges for 37" & 47" High Island Modules

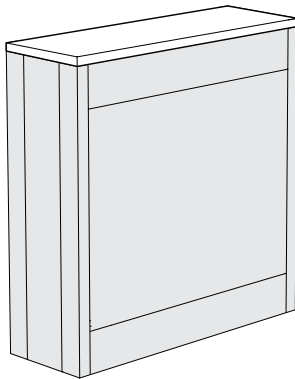

Length	Kemresin®	Phenolic Resin	High Pressure Laminate
24"	<b>F92R1224-00</b>	<b>F92T1224-00</b>	<b>F92P1224-00</b>
30"	<b>F92R1230-00</b>	<b>F92T1230-00</b>	<b>F92P1230-00</b>
36"	<b>F92R1236-00</b>	<b>F92T1236-00</b>	<b>F92P1236-00</b>
42"	<b>F92R1242-00</b>	<b>F92T1242-00</b>	<b>F92P1242-00</b>
48"	<b>F92R1248-00</b>	<b>F92T1248-00</b>	<b>F92P1248-00</b>
54"	<b>F92R1254-00</b>	<b>F92T1254-00</b>	<b>F92P1254-00</b>
60"	<b>F92R1260-00</b>	<b>F92T1260-00</b>	<b>F92P1260-00</b>
66"	<b>F92R1266-00</b>	<b>F92T1266-00</b>	<b>F92P1266-00</b>
72"	<b>F92R1272-00</b>	<b>F92T1272-00</b>	<b>F92P1272-00</b>

### 12" Deep Module Ledges for 84" High Island Modules with Upper Carriers

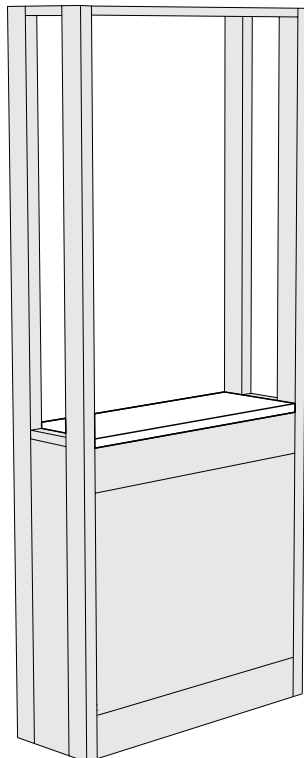

Length	Kemresin®	Phenolic Resin	High Pressure Laminate
24"	<b>F90R1224-00</b>	<b>F90T1224-00</b>	<b>F90P1224-00</b>
30"	<b>F90R1230-00</b>	<b>F90T1230-00</b>	<b>F90P1230-00</b>
36"	<b>F90R1236-00</b>	<b>F90T1236-00</b>	<b>F90P1236-00</b>
42"	<b>F90R1242-00</b>	<b>F90T1242-00</b>	<b>F90P1242-00</b>
48"	<b>F90R1248-00</b>	<b>F90T1248-00</b>	<b>F90P1248-00</b>
54"	<b>F90R1254-00</b>	<b>F90T1254-00</b>	<b>F90P1254-00</b>
60"	<b>F90R1260-00</b>	<b>F90T1260-00</b>	<b>F90P1260-00</b>
66"	<b>F90R1266-00</b>	<b>F90T1266-00</b>	<b>F90P1266-00</b>
72"	<b>F90R1272-00</b>	<b>F90T1272-00</b>	<b>F90P1272-00</b>

#### Module End Caps

Depth	Kemresin®	Phenolic Resin	High Pressure Laminate
6"	<b>F91R0206-00</b>	<b>F91T0206-00</b>	<b>F91P0206-00</b>

#### Color Option Code

##### Kemresin

**BK** = Black      **GR** = Grey      **PT**=Putty      **SL** = Slate

Kemresin is available in four standard colors. To specify Kemresin color, place a dash and the two-letter code at the end of the part number.

**Example:** F92R1224-00-**BK** for Black

If no color is specified, Kemresin will be furnished in Black.

##### Phenolic Resin - High Pressure Laminate

Phenolic Resin and High Pressure Laminate is furnished in Black standard.

# Module Ledges

## Specifications:

Module Ledges are required to cover the open top of Wall and Island Structural Modules. They are most commonly ordered in the same material and color as the Worksurface Tops, but it is not required.

Module Ledges are 1" thick with all edges finished square. They should be ordered to match the module size on which they are to be used. The actual ledge is

3/4" less in length than the module. The remaining space is covered by the Module End Caps and/or Upper Carrier Uprights which are supplied with the Structural Module.

Additional Module End Caps may be purchased for future reconfiguring, but they are not required.

### 6" Deep Module Ledge for 37" & 47" High Partition Modules

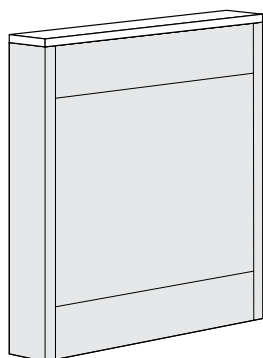

Length	Kemresin®	Phenolic Resin	High Pressure Laminate
24"	<b>F92R0624-00</b>	<b>F92T0624-00</b>	<b>F92P0624-00</b>
30"	<b>F92R0630-00</b>	<b>F92T0630-00</b>	<b>F92P0630-00</b>
36"	<b>F92R0636-00</b>	<b>F92T0636-00</b>	<b>F92P0636-00</b>
42"	<b>F92R0642-00</b>	<b>F92T0642-00</b>	<b>F92P0642-00</b>
48"	<b>F92R0648-00</b>	<b>F92T0648-00</b>	<b>F92P0648-00</b>
54"	<b>F92R0654-00</b>	<b>F92T0654-00</b>	<b>F92P0654-00</b>
60"	<b>F92R0660-00</b>	<b>F92T0660-00</b>	<b>F92P0660-00</b>
66"	<b>F92R0666-00</b>	<b>F92T0666-00</b>	<b>F92P0666-00</b>
72"	<b>F92R0672-00</b>	<b>F92T0672-00</b>	<b>F92P0672-00</b>

### 6" Deep Module Ledge for 84" High Partition Modules with Upper Carriers

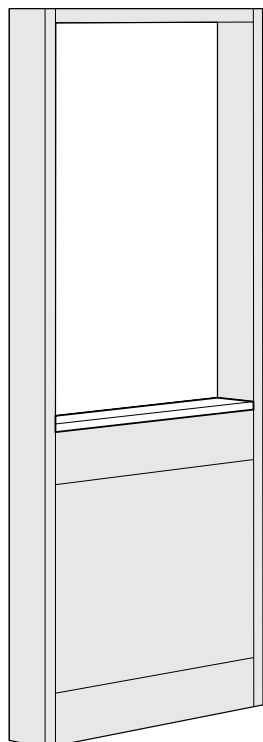

Length	Kemresin®	Phenolic Resin	High Pressure Laminate
24"	<b>F90R0624-00</b>	<b>F90T0624-00</b>	<b>F90P0624-00</b>
30"	<b>F90R0630-00</b>	<b>F90T0630-00</b>	<b>F90P0630-00</b>
36"	<b>F90R0636-00</b>	<b>F90T0636-00</b>	<b>F90P0636-00</b>
42"	<b>F90R0642-00</b>	<b>F90T0642-00</b>	<b>F90P0642-00</b>
48"	<b>F90R0648-00</b>	<b>F90T0648-00</b>	<b>F90P0648-00</b>
54"	<b>F90R0654-00</b>	<b>F90T0654-00</b>	<b>F90P0654-00</b>
60"	<b>F90R0660-00</b>	<b>F90T0660-00</b>	<b>F90P0660-00</b>
66"	<b>F90R0666-00</b>	<b>F90T0666-00</b>	<b>F90P0666-00</b>
72"	<b>F90R0672-00</b>	<b>F90T0672-00</b>	<b>F90P0672-00</b>

### Corner & Peninsula Column Module Ledges

Length	Kemresin®	Phenolic Resin	High Pressure Laminate
6" x 6"	<b>F90R0606-00</b>	<b>F90T0606-00</b>	<b>F90P0606-00</b>
9" x 9"	<b>F90R0909-00</b>	<b>F90T0909-00</b>	<b>F90P0909-00</b>
9" x 12"	<b>F90R0912-00</b>	<b>F90T0912-00</b>	<b>F90P0912-00</b>
12" x 12"	<b>F90R1212-00</b>	<b>F90T1212-00</b>	<b>F90P1212-00</b>

### Color Option Code

#### Kemresin

**BK** = Black      **GR** = Grey      **PT**=Putty      **SL** = Slate

Kemresin is available in four standard colors. To specify Kemresin color, place a dash and the two-letter code at the end of the part number.

**Example:** F92R0624-00-**BK** for Black

If no color is specified, Kemresin will be furnished in Black.

#### Phenolic Resin - High Pressure Laminate

Phenolic Resin and High Pressure Laminate is furnished in Black standard.

# Worksurface Tops

## Specifications:

Worksurface Tops are available in modular sizes to match the length and depth of the Worksurface Frames. They are also available in depths 1" less than the Worksurface Frames to create a "Cord Gap" behind the top. This gap allows cords, cables and flexible tubing to be routed below the worksurface, and out of the way of ongoing work.

Worksurface Tops are 1" thick. Front edges are treated as shown on page 69. All other edges are finished square.

When Worksurface Tops spanning more than one frame are desired or when cutouts are required, custom tops are available. See page 70 and 71 for more information.

## Modular Worksurface Tops

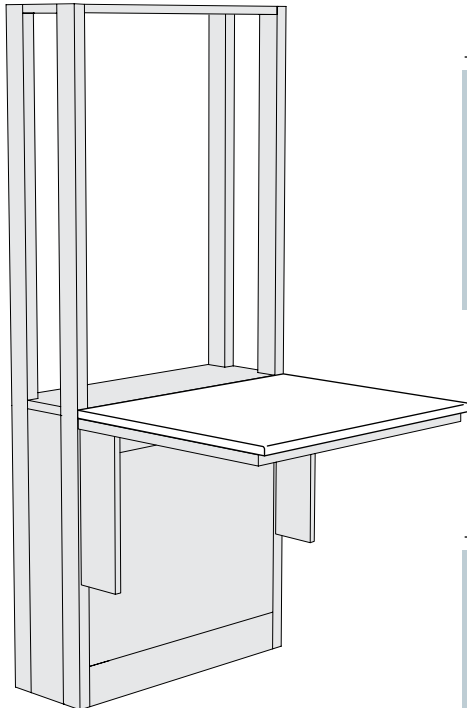

	Length	Kemresin®	Phenolic Resin	High Pressure Laminate
<b>24" DEEP</b>	24"	<b>F95R2424-00</b>	<b>F95T2424-00</b>	<b>F95P2424-00</b>
	30"	<b>F95R2430-00</b>	<b>F95T2430-00</b>	<b>F95P2430-00</b>
	36"	<b>F95R2436-00</b>	<b>F95T2436-00</b>	<b>F95P2436-00</b>
	42"	<b>F95R2442-00</b>	<b>F95T2442-00</b>	<b>F95P2442-00</b>
	48"	<b>F95R2448-00</b>	<b>F95T2448-00</b>	<b>F95P2448-00</b>
	54"	<b>F95R2454-00</b>	<b>F95T2454-00</b>	<b>F95P2454-00</b>
	60"	<b>F95R2460-00</b>	<b>F95T2460-00</b>	<b>F95P2460-00</b>
	66"	<b>F95R2466-00</b>	<b>F95T2466-00</b>	<b>F95P2466-00</b>
72"	<b>F95R2472-00</b>	<b>F95T2472-00</b>	<b>F95P2472-00</b>	

	Length	Kemresin®	Phenolic Resin	High Pressure Laminate
<b>30" DEEP</b>	24"	<b>F95R3024-00</b>	<b>F95T3024-00</b>	<b>F95P3024-00</b>
	30"	<b>F95R3030-00</b>	<b>F95T3030-00</b>	<b>F95P3030-00</b>
	36"	<b>F95R3036-00</b>	<b>F95T3036-00</b>	<b>F95P3036-00</b>
	42"	<b>F95R3042-00</b>	<b>F95T3042-00</b>	<b>F95P3042-00</b>
	48"	<b>F95R3048-00</b>	<b>F95T3048-00</b>	<b>F95P3048-00</b>
	54"	<b>F95R3054-00</b>	<b>F95T3054-00</b>	<b>F95P3054-00</b>
	60"	<b>F95R3060-00</b>	<b>F95T3060-00</b>	<b>F95P3060-00</b>
	66"	<b>F95R3066-00</b>	<b>F95T3066-00</b>	<b>F95P3066-00</b>
72"	<b>F95R3072-00</b>	<b>F95T3072-00</b>	<b>F95P3072-00</b>	

### Color Option Code

#### Kemresin

**BK** = Black      **GR** = Grey      **PT**=Putty      **SL** = Slate

Kemresin is available in four standard colors. To specify Kemresin color, place a dash and the two-letter code at the end of the part number.

**Example:** F95R2424-00-**BK** for Black

If no color is specified, Kemresin will be furnished in Black.

#### Phenolic Resin - High Pressure Laminate

Phenolic Resin and High Pressure Laminate is furnished in Black standard.

# Worksurface Tops

### Specifications:

Worksurface Tops are available in modular sizes to match the length and depth of the Worksurface Frames. They are also available in depths 1" less than the Worksurface Frames to create a "Cord Gap" behind the top. This gap allows cords, cables and flexible tubing to be routed below the worksurface, and out of the way of ongoing work.

Worksurface Tops are 1" thick. Front edges are treated as shown on page 69. All other edges are finished square.

When Worksurface Tops spanning more than one frame are desired or when cutouts are required, custom tops are available. See page 70 and 71 for more information.

### Modular Worksurface Tops with Cord Gap

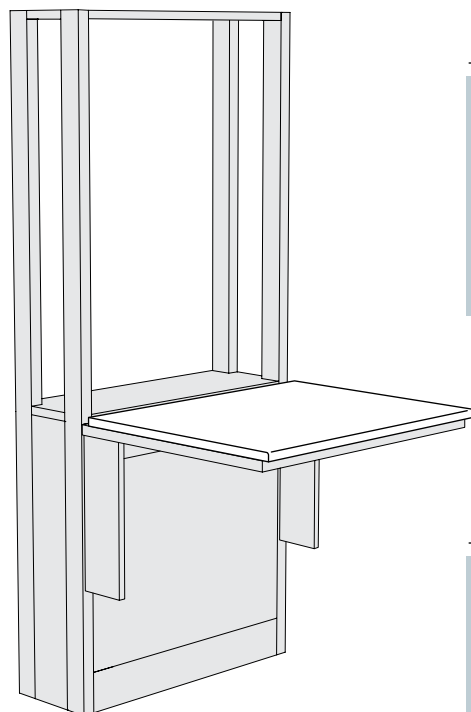

	Length	Kemresin®	Phenolic Resin	High Pressure Laminate
<b>23" DEEP</b>	24"	<b>F95R2324-00</b>	<b>F95T2324-00</b>	<b>F95P2324-00</b>
	30"	<b>F95R2330-00</b>	<b>F95T2330-00</b>	<b>F95P2330-00</b>
	36"	<b>F95R2336-00</b>	<b>F95T2336-00</b>	<b>F95P2336-00</b>
	42"	<b>F95R2342-00</b>	<b>F95T2342-00</b>	<b>F95P2342-00</b>
	48"	<b>F95R2348-00</b>	<b>F95T2348-00</b>	<b>F95P2348-00</b>
	54"	<b>F95R2354-00</b>	<b>F95T2354-00</b>	<b>F95P2354-00</b>
	60"	<b>F95R2360-00</b>	<b>F95T2360-00</b>	<b>F95P2360-00</b>
	66"	<b>F95R2366-00</b>	<b>F95T2366-00</b>	<b>F95P2366-00</b>
	72"	<b>F95R2372-00</b>	<b>F95T2372-00</b>	<b>F95P2372-00</b>

	Length	Kemresin®	Phenolic Resin	High Pressure Laminate
<b>29" DEEP</b>	24"	<b>F95R2924-00</b>	<b>F95T2924-00</b>	<b>F95P2924-00</b>
	30"	<b>F95R2930-00</b>	<b>F95T2930-00</b>	<b>F95P2930-00</b>
	36"	<b>F95R2936-00</b>	<b>F95T2936-00</b>	<b>F95P2936-00</b>
	42"	<b>F95R2942-00</b>	<b>F95T2942-00</b>	<b>F95P2942-00</b>
	48"	<b>F95R2948-00</b>	<b>F95T2948-00</b>	<b>F95P2948-00</b>
	54"	<b>F95R2954-00</b>	<b>F95T2954-00</b>	<b>F95P2954-00</b>
	60"	<b>F95R2960-00</b>	<b>F95T2960-00</b>	<b>F95P2960-00</b>
	66"	<b>F95R2966-00</b>	<b>F95T2966-00</b>	<b>F95P2966-00</b>
	72"	<b>F95R2972-00</b>	<b>F95T2972-00</b>	<b>F95P2972-00</b>

### Color Option Code

#### Kemresin

**BK** = Black      **GR** = Grey      **PT**=Putty      **SL** = Slate

Kemresin is available in four standard colors. To specify Kemresin color, place a dash and the two-letter code at the end of the part number.

**Example:** F95R2324-00-**BK** for Black

If no color is specified, Kemresin will be furnished in Black.

#### Phenolic Resin - High Pressure Laminate

Phenolic Resin and High Pressure Laminate is furnished in Black standard.

# Corner Worksurface Tops

## Specifications:

Worksurface Tops are available in modular sizes to match the length and depth of the Worksurface Frames. They are also available in depths 1" less than the Worksurface Frames to create a "Cord Gap" behind the top. This gap allows cords, cables and flexible tubing to be routed below the worksurface, and out of the way of ongoing work.

Worksurface Tops are 1" thick. Front edges are treated as shown on page 69 All other edges are finished square.

When Worksurface Tops spanning more than one frame are desired or when cutouts are required, custom tops are available. See page 70 and 71 for more information.

## Modular Corner Worksurface Tops

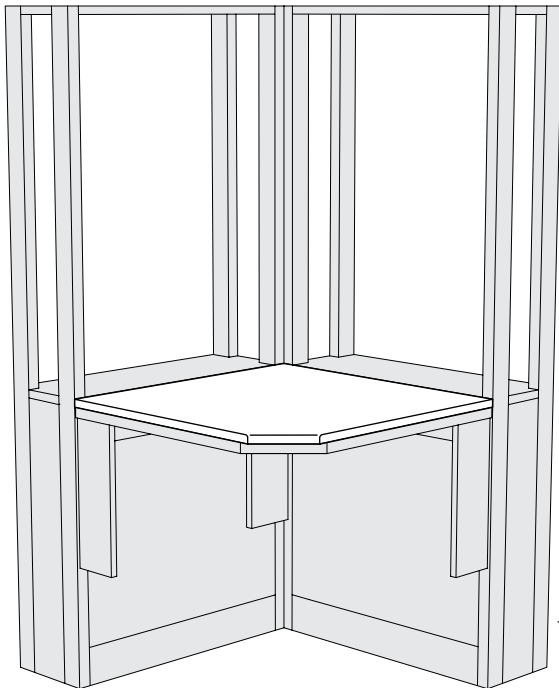

Depth	Length	Kemresin®	Phenolic Resin	High Pressure Laminate
23"	36"	<b>F96R2336-00</b>	<b>F96T2336-00</b>	<b>F96P2336-00</b>
23"	42"	<b>F96R2342-00</b>	<b>F96T2342-00</b>	<b>F96P2342-00</b>
23"	48"	<b>F96R2348-00</b>	<b>F96T2348-00</b>	<b>F96P2348-00</b>
24"	36"	<b>F96R2436-00</b>	<b>F96T2436-00</b>	<b>F96P2436-00</b>
24"	42"	<b>F96R2442-00</b>	<b>F96T2442-00</b>	<b>F96P2442-00</b>
24"	48"	<b>F96R2448-00</b>	<b>F96T2448-00</b>	<b>F96P2448-00</b>
29"	36"	<b>F96R2936-00</b>	<b>F96T2936-00</b>	<b>F96P2936-00</b>
29"	42"	<b>F96R2942-00</b>	<b>F96T2942-00</b>	<b>F96P2942-00</b>
29"	48"	<b>F96R2948-00</b>	<b>F96T2948-00</b>	<b>F96P2948-00</b>
30"	36"	<b>F96R3036-00</b>	<b>F96T3036-00</b>	<b>F96P3036-00</b>
30"	42"	<b>F96R3042-00</b>	<b>F96T3042-00</b>	<b>F96P3042-00</b>
30"	48"	<b>F96R3048-00</b>	<b>F96T3048-00</b>	<b>F96P3048-00</b>

### Color Option Code

#### Kemresin

**BK** = Black      **GR** = Grey      **PT**=Putty      **SL** = Slate

Kemresin is available in four standard colors. To specify Kemresin color, place a dash and the two-letter code at the end of the part number.

**Example:** F96R2336-00-**BK** for Black

If no color is specified, Kemresin will be furnished in Black.

#### Phenolic Resin - High Pressure Laminate

Phenolic Resin and High Pressure Laminate is furnished in Black standard.

# Work Top and Ledge Materials

## Specifications:

Worksurface Top and Ledge material selections are among the most critical of the laboratory furniture decisions. The intended applications of your work tops dictate material choice. Surfaces could be exposed to reagents and caustic substances. Heavy equipment may need to be supported or only light duty tasks may be performed.

Kewaunee offers three basic work top materials for use on the Alpha System. They are Kewaunee's exclusive Kemresin®, Phenolic Resin and High Pressure Plastic Laminates. All are available in standard sizes to match the Alpha System modules and are complimented with appropriate sinks, drains and accessories.

## Work Top and Ledge Material Comparison

MATERIAL	APPEARANCE	COMPOSITION	CHEMICAL RESISTANCE	APPLICATIONS
KEMRESIN®	Black, Grey, Putty, or Slate, ultra-smooth, non-porous	1" thick molded epoxy resin	Excellent resistance to practically all acids, alkalies and solvents	Use wherever optimum physical and chemical resisting properties are required
PHENOLIC RESIN	Hard, smooth surface, various colors	Cellulose fiber reinforced phenolic resin core with a highly crosslinked polyurethane copolymer surface	Excellent resistance to practically all acids, alkalies and solvents	Chemical and biological labs
HIGH PRESSURE LAMINATES	Hard, smooth surface, various colors	Plastic laminate surface attached with water resistant adhesive to solid particle board	Fair chemical resistance to wide range of acids, alkalies and solvents (Strong reagent solutions do attack, and material is almost impossible to repair satisfactorily)	Recommended for light duty purposes in science and technical laboratories or educational institutions, and for pharmacies and nurses stations in hospitals

## Work Top Styles — Front Edge



**Kewaunee KEMRESIN®**  
1/8" Chamfer



**Phenolic Resin**  
1/8" Chamfer

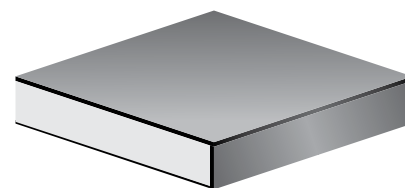

**HIGH PRESSURE LAMINATES**  
Square – Self-Edged

## Color Selection:

### Kewaunee KEMRESIN®

Black  
Grey  
Putty  
Slate

### PHENOLIC RESIN

Phenolic Resin is furnished Black as standard. Other colors and patterns are available on special order. Contact your Kewaunee representative for current offerings.

### HIGH PRESSURE LAMINATES

High-Pressure Laminate is furnished Black as standard. Other colors and patterns are available on special order. Contact your Kewaunee representative for current offerings.

# Custom Worksurface Tops and Ledges

## Specifications:

Recognizing that requirements for laboratory service fixtures and fittings is highly individualized, and that no one solution works in all cases, Alpha System Ledges and Worksurface Tops may be modified to accommodate fixture, fitting, sink, drain, and accessory cutouts as required.

Kewaunee's nationwide network of sales representatives and designers are available to help.

## Worksurface Tops and Ledges with Holes and Cutouts

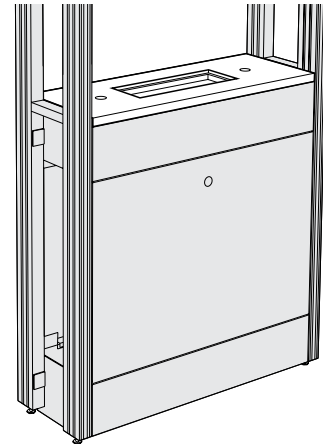
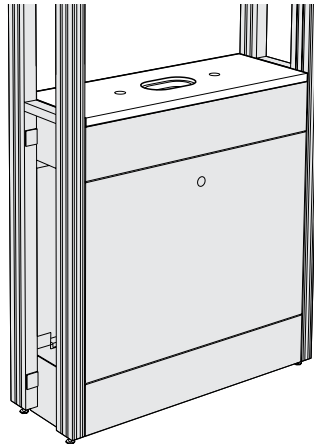
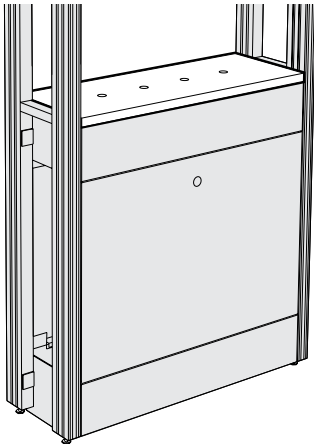

Module ledges may be ordered with cupsink cutouts and/or holes for mounting fittings and fixtures.

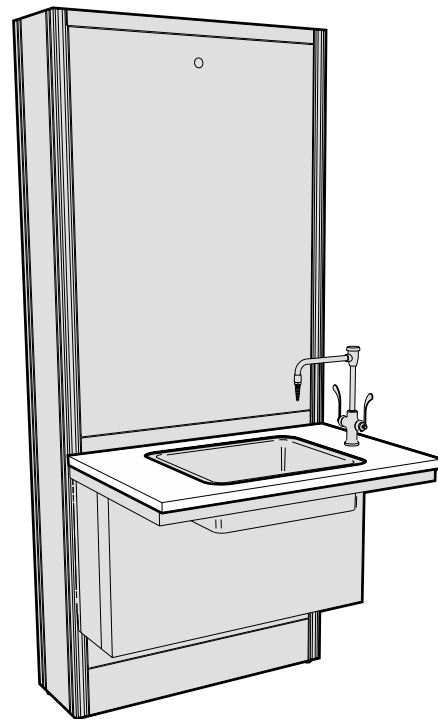
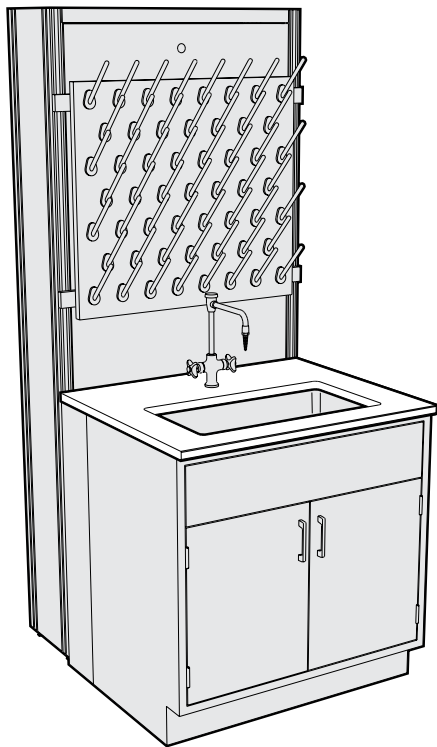

Worksurface tops may be ordered with sink cutouts, service fitting holes, specialty cutouts or other modifications.

# Custom Work Tops

**Specifications:**

Continuous worksurface tops are available in two basic styles for applications that require an uninterrupted surface. All three top materials, Kemresin, Phenolic Resin, and High Pressure Laminate, may be fabricated into both flat tops, or flat tops with 1" thick applied curbs at the rear.

Fitting and fixture holes and cutouts can be incorporated in these styles to allow unlimited design options.

See charts below for material size and color options.

**1" Thick Flat Worksurface Top**

Standard Depths      24"      30"

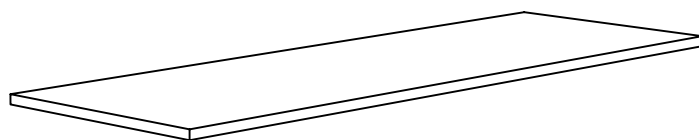

Available Materials	Maximum Length without Joint
<b>Kewaunee Kemresin®</b>	96"
<b>Phenolic Resin</b>	120"
<b>High Pressure Laminate</b>	120"

**1" Thick Worksurface Top with 1" x 4" Applied Curb**

Standard Depths      24"      30"

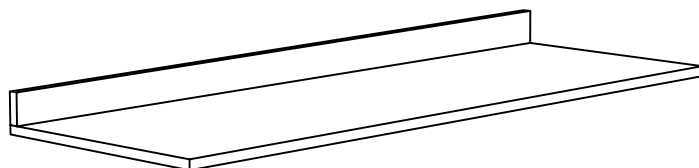

Available Materials	Maximum Length without Joint
<b>Kewaunee Kemresin®</b>	96"
<b>Phenolic Resin</b>	120"
<b>High Pressure Laminate</b>	120"

**Color Selection:**

**Kewaunee KEMRESIN®**

- Black
- Grey
- Putty
- Slate

**PHENOLIC RESIN**

Phenolic Resin is furnished Black as standard. Other colors and patterns are available on special order. Contact your Kewaunee representative for current offerings.

**HIGH PRESSURE LAMINATES**

High-Pressure Laminate is furnished Black as standard. Other colors and patterns are available on special order. Contact your Kewaunee representative for current offerings.



# Suspended Base Cabinets

## Features:

### Steel Base Cabinets

- Electrostatically applied, chemical resistant, powder coat finish available in colors to compliment the laboratory environment
- Heavy gauge formed and welded steel cabinet body construction provides strength and durability
- One piece drawer body-bottom, back, sides and inner drawer head, radiused all four sides
- Full-extension, side mounted, soft-close slides.
- One-piece case bottom and horizontal front rail
- Flush face corner construction
- Five-knuckle institutional type stainless steel hinge, 2<sup>3</sup>/<sub>4</sub>" high

### Wood Base Cabinets

- Multiple coat, chemical resistant finish system formulated to highlight the natural grain patterns
- Dovetailed drawer construction with nine-ply hardwood plywood drawer sides
- 3/4" seven-ply hardwood plywood end panels, bottom and shelf, with solid hardwood facing
- Full-extension, ball bearing, drawer slides
- One-piece 1/4" hardboard back, dadoed into end panels and bottom and securely fastened
- Five-knuckle institutional type stainless steel offset door hinges rated for 150 pound loads



# Suspended Base Cabinets – 19" High

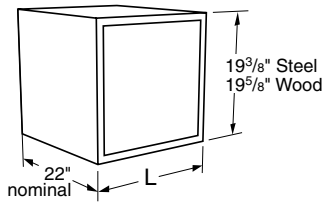

### Specifications:

Suspended Base Cabinets are designed to hang beneath Cantilevered Worksurface or Table Frames. They are available in either steel or wood construction and are furnished with all hardware required for attachment to the frame.

Cabinets on this page are a nominal 19" high, and are available in lengths shown.

See page 98 and 99 for designating cabinet style, door and drawer head material, and hardware selection.

## Open Base Cabinets



Steel Cabinet	Length	Wood Cabinet
<b>B00C192215-00_0</b>	15"	<b>B00W202215-00_0</b>
<b>B00C192218-00_0</b>	18"	<b>B00W202218-00_0</b>
<b>B00C192221-00_0</b>	21"	<b>B00W202221-00_0</b>
<b>B00C192224-00_0</b>	24"	<b>B00W202224-00_0</b>



Steel Cabinet	Length	Wood Cabinet
<b>B00C192230-00_0</b>	30"	<b>B00W202230-00_0</b>
<b>B00C192236-00_0</b>	36"	<b>B00W202236-00_0</b>
<b>B00C192242-00_0</b>	42"	<b>B00W202242-00_0</b>
<b>B00C192248-00_0</b>	48"	<b>B00W202248-00_0</b>



## Cupboard Base Cabinets

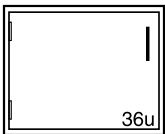

Steel Cabinet	Length	Wood Cabinet
<b>C03C192215L</b>	15"	<b>C03W202215L</b>
<b>C03C192218L</b>	18"	<b>C03W202218L</b>
<b>C03C192221L</b>	21"	<b>C03W202221L</b>
<b>C03C192224L</b>	24"	<b>C03W202224L</b>

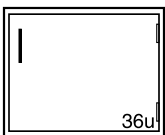
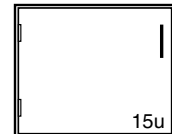

Steel Cabinet	Length	Wood Cabinet
<b>C03C192215-</b>	15"	<b>C03W202215-</b>
<b>C03C192218-</b>	18"	<b>C03W202218-</b>
<b>C03C192221-</b>	21"	<b>C03W202221-</b>
<b>C03C192224-</b>	24"	<b>C03W202224-</b>

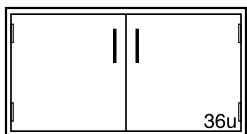
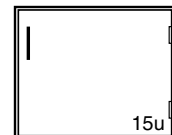

Steel Cabinet	Length	Wood Cabinet
<b>C03C192230-</b>	30"	<b>C03W202230-</b>
<b>C03C192236-</b>	36"	<b>C03W202236-</b>
<b>C03C192242-</b>	42"	<b>C03W202242-</b>
<b>C03C192248-</b>	48"	<b>C03W202248-</b>

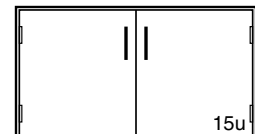

# Suspended Base Cabinets – 19" High

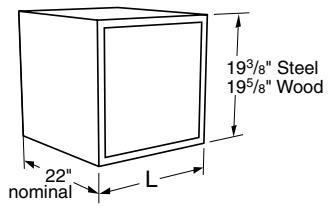

**Specifications:**  
 Suspended Base Cabinets are designed to hang beneath Cantilevered Worksurface or Table Frames. They are available in either steel or wood construction and are furnished with all hardware required for attachment to the frame.

Cabinets on this page are a nominal 19" high, and are available in lengths shown.

See page 98 and 99 for designating cabinet style, door and drawer head material, and hardware selection.

## Drawer Base Cabinets

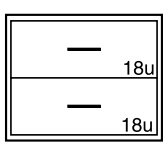

Steel Cabinet	Length	Wood Cabinet
<b>D00C192215-</b> -----	15"	<b>D00W202215- 0</b> -----
<b>D00C192218-</b> -----	18"	<b>D00W202218- 0</b> -----
<b>D00C192221-</b> -----	21"	<b>D00W202221- 0</b> -----
<b>D00C192224-</b> -----	24"	<b>D00W202224- 0</b> -----

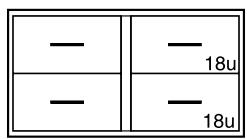
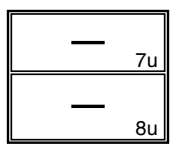

Steel Cabinet	Length	Wood Cabinet
<b>D02C192230-</b> -----	30"	<b>D02W202230- 0</b> -----
<b>D02C192236-</b> -----	36"	<b>D02W202236- 0</b> -----
<b>D02C192242-</b> -----	42"	<b>D02W202242- 0</b> -----
<b>D02C192248-</b> -----	48"	<b>D02W202248- 0</b> -----

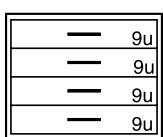
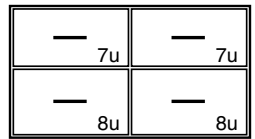

Steel Cabinet	Length	Wood Cabinet
<b>D30C192215-</b> -----	15"	<b>D30W202215- 0</b> -----
<b>D30C192218-</b> -----	18"	<b>D30W202218- 0</b> -----
<b>D30C192221-</b> -----	21"	<b>D30W202221- 0</b> -----
<b>D30C192224-</b> -----	24"	<b>D30W202224- 0</b> -----

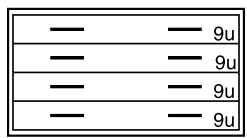
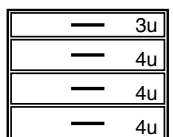

Steel Cabinet	Length	Wood Cabinet
<b>D30C192230-</b> -----	30"	<b>D30W202230- 0</b> -----
<b>D30C192236-</b> -----	36"	<b>D30W202236- 0</b> -----
<b>D30C192242-</b> -----	42"	<b>D30W202242- 0</b> -----
<b>D30C192248-</b> -----	48"	<b>D30W202248- 0</b> -----

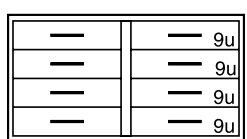
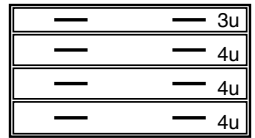

Steel Cabinet	Length	Wood Cabinet
<b>D32C192230-</b> -----	30"	<b>D32W202230- 0</b> -----
<b>D32C192236-</b> -----	36"	<b>D32W202236- 0</b> -----
<b>D32C192242-</b> -----	42"	<b>D32W202242- 0</b> -----
<b>D32C192248-</b> -----	48"	<b>D32W202248- 0</b> -----

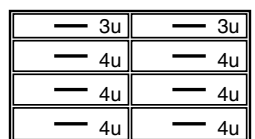

# Suspended Base Cabinets – 19" High

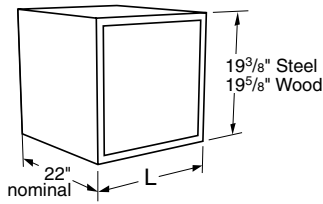

**Specifications:**

Suspended Base Cabinets are designed to hang beneath Cantilevered Worksurface or Table Frames. They are available in either steel or wood construction and are furnished with all hardware required for attachment to the frame.

Cabinets on this page are a nominal 19" high, and are available in lengths shown.

See page 98 and 99 for designating cabinet style, door and drawer head material, and hardware selection.

**Drawer Base Cabinets**

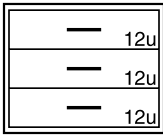

Steel Cabinet	Length	Wood Cabinet
<b>D50C192215-</b> -----	15"	<b>D50W202215-</b> 0
<b>D50C192218-</b> -----	18"	<b>D50W202218-</b> 0
<b>D50C192221-</b> -----	21"	<b>D50W202221-</b> 0
<b>D50C192224-</b> -----	24"	<b>D50W202224-</b> 0

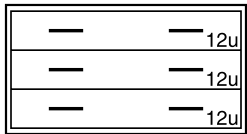
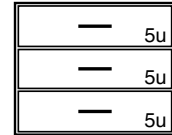

Steel Cabinet	Length	Wood Cabinet
<b>D50C192230-</b> -----	30"	<b>D50W202230-</b> 0
<b>D50C192236-</b> -----	36"	<b>D50W202236-</b> 0
<b>D50C192242-</b> -----	42"	<b>D50W202242-</b> 0
<b>D50C192248-</b> -----	48"	<b>D50W202248-</b> 0

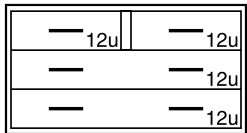
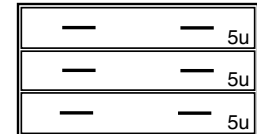

Steel Cabinet	Length	Wood Cabinet
<b>D51C192230-</b> -----	30"	<b>D51W202230-</b> 0
<b>D51C192236-</b> -----	36"	<b>D51W202236-</b> 0
<b>D51C192242-</b> -----	42"	<b>D51W202242-</b> 0
<b>D51C192248-</b> -----	48"	<b>D51W202248-</b> 0

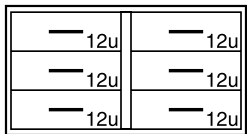
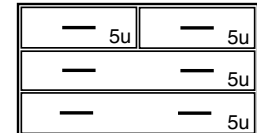

Steel Cabinet	Length	Wood Cabinet
<b>D52C192230-</b> -----	30"	<b>D52W202230-</b> 0
<b>D52C192236-</b> -----	36"	<b>D52W202236-</b> 0
<b>D52C192242-</b> -----	42"	<b>D52W202242-</b> 0
<b>D52C192248-</b> -----	48"	<b>D52W202248-</b> 0

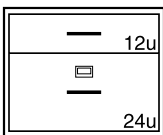
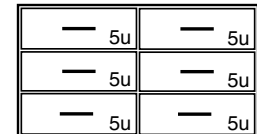

Steel Cabinet	Length	Wood Cabinet
<b>D81C192215-</b> -----	15"	<b>D81W202215-</b> 0
<b>D81C192218-</b> -----	18"	<b>D81W202218-</b> 0
<b>D81C192221-</b> -----	21"	<b>D81W202221-</b> 0
<b>D81C192224-</b> -----	24"	<b>D81W202224-</b> 0

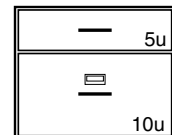

1 File Drawer with hangers

1 File Drawer with hangers

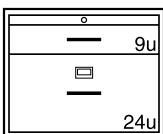

Steel Cabinet	Length	Wood Cabinet
<b>D85C192215-</b> -----	15"	<b>D85W202215-</b> 0
<b>D85C192218-</b> -----	18"	<b>D85W202218-</b> 0
<b>D85C192221-</b> -----	21"	<b>D85W202221-</b> 0
<b>D85C192224-</b> -----	24"	<b>D85W202224-</b> 0

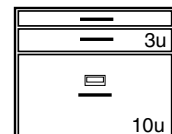

Pullboard  
1 File Drawer with hangers

Pullboard  
1 File Drawer with hangers

# Suspended Base Cabinets – 19" High

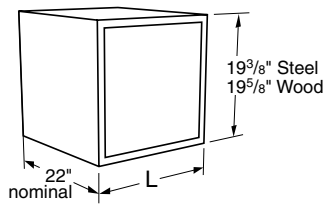

**Specifications:**  
 Suspended Base Cabinets are designed to hang beneath Cantilevered Worksurface or Table Frames. They are available in either steel or wood construction and are furnished with all hardware required for attachment to the frame.  
 Cabinets on this page are a nominal 19" high, and are available in lengths shown.  
 See page 98 and 99 for designating cabinet style, door and drawer head material, and hardware selection.

## Drawer Base Cabinets

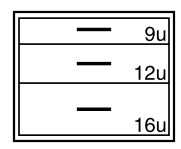

Steel Cabinet	Length	Wood Cabinet
<b>D86C192215-</b> -----	15"	<b>D86W202215- 0</b> -----
<b>D86C192218-</b> -----	18"	<b>D86W202218- 0</b> -----
<b>D86C192221-</b> -----	21"	<b>D86W202221- 0</b> -----
<b>D86C192224-</b> -----	24"	<b>D86W202224- 0</b> -----

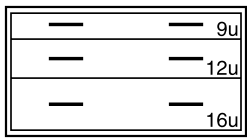
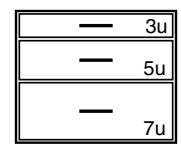

Steel Cabinet	Length	Wood Cabinet
<b>D86C192230-</b> -----	30"	<b>D86W202230- 0</b> -----
<b>D86C192236-</b> -----	36"	<b>D86W202236- 0</b> -----
<b>D86C192242-</b> -----	42"	<b>D86W202242- 0</b> -----
<b>D86C192248-</b> -----	48"	<b>D86W202248- 0</b> -----

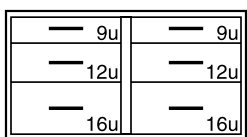
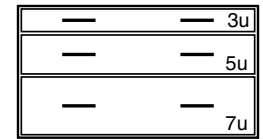

Steel Cabinet	Length	Wood Cabinet
<b>D87C192230-</b> -----	30"	<b>D87W202230- 0</b> -----
<b>D87C192236-</b> -----	36"	<b>D87W202236- 0</b> -----
<b>D87C192242-</b> -----	42"	<b>D87W202242- 0</b> -----
<b>D87C192248-</b> -----	48"	<b>D87W202248- 0</b> -----

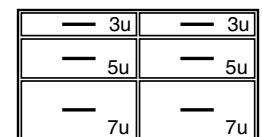

## Drawer & Cupboard Base Cabinets

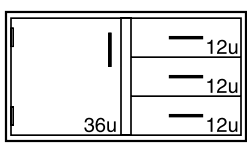

Steel Cabinet	Length	Wood Cabinet
<b>E43C192230L</b> -----	30"	<b>E43W202230L</b> -----
<b>E43C192236L</b> -----	36"	<b>E43W202236L</b> -----
<b>E43C192242L</b> -----	42"	<b>E43W202242L</b> -----
<b>E43C192248L</b> -----	48"	<b>E43W202248L</b> -----

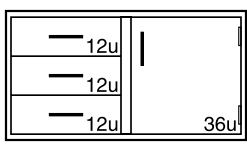
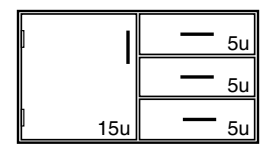

Steel Cabinet	Length	Wood Cabinet
<b>E43C192230-</b> -----	30"	<b>E43W202230-</b> -----
<b>E43C192236-</b> -----	36"	<b>E43W202236-</b> -----
<b>E43C192242-</b> -----	42"	<b>E43W202242-</b> -----
<b>E43C192248-</b> -----	48"	<b>E43W202248-</b> -----

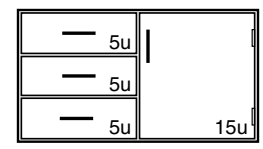

# Suspended Base Cabinets – 25" High

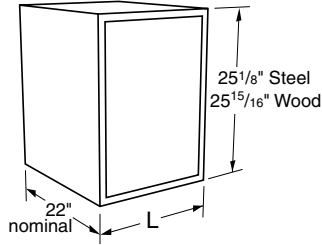

**Specifications:**

Suspended Base Cabinets are designed to hang beneath Cantilevered Worksurface or Table Frames. They are available in either steel or wood construction and are furnished with all hardware required for attachment to the frame.

Cabinets on this page are a nominal 25" high, and are available in lengths shown.

See page 98 and 99 for designating cabinet style, door and drawer head material, and hardware selection.

**Open Base Cabinets**

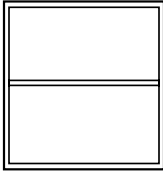

Steel Cabinet	Length	Wood Cabinet
<b>B00C252215-00_0</b>	15"	<b>B00W262215-00_0</b>
<b>B00C252218-00_0</b>	18"	<b>B00W262218-00_0</b>
<b>B00C252221-00_0</b>	21"	<b>B00W262221-00_0</b>
<b>B00C252224-00_0</b>	24"	<b>B00W262224-00_0</b>

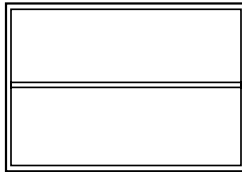
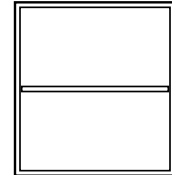

Steel Cabinet	Length	Wood Cabinet
<b>B00C252230-00_0</b>	30"	<b>B00W262230-00_0</b>
<b>B00C252236-00_0</b>	36"	<b>B00W262236-00_0</b>
<b>B00C252242-00_0</b>	42"	<b>B00W262242-00_0</b>
<b>B00C252248-00_0</b>	48"	<b>B00W262248-00_0</b>



**Cupboard Base Cabinets**

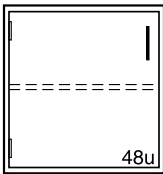

Steel Cabinet	Length	Wood Cabinet
<b>C03C252215L</b>	15"	<b>C03W262215L_0</b>
<b>C03C252218L</b>	18"	<b>C03W262218L_0</b>
<b>C03C252221L</b>	21"	<b>C03W262221L_0</b>
<b>C03C252224L</b>	24"	<b>C03W262224L_0</b>

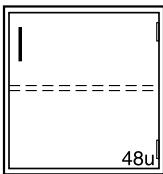
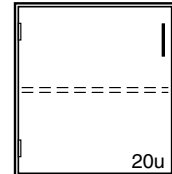

Steel Cabinet	Length	Wood Cabinet
<b>C03C252215-</b>	15"	<b>C03W262215-_0</b>
<b>C03C252218-</b>	18"	<b>C03W262218-_0</b>
<b>C03C252221-</b>	21"	<b>C03W262221-_0</b>
<b>C03C252224-</b>	24"	<b>C03W262224-_0</b>

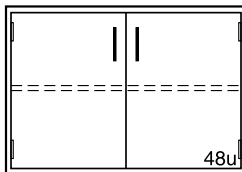
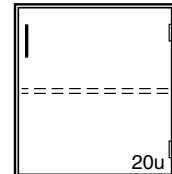

Steel Cabinet	Length	Wood Cabinet
<b>C03C252230-</b>	30"	<b>C03W262230-_0</b>
<b>C03C252236-</b>	36"	<b>C03W262236-_0</b>
<b>C03C252242-</b>	42"	<b>C03W262242-_0</b>
<b>C03C252248-</b>	48"	<b>C03W262248-_0</b>

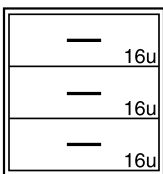
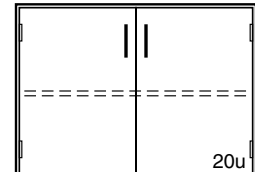

Steel Cabinet	Length	Wood Cabinet
<b>D00C252215-</b>	15"	<b>D00W262215-_0</b>
<b>D00C252218-</b>	18"	<b>D00W262218-_0</b>
<b>D00C252221-</b>	21"	<b>D00W262221-_0</b>
<b>D00C252224-</b>	24"	<b>D00W262224-_0</b>

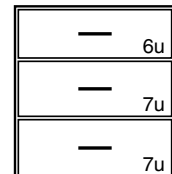

# Suspended Base Cabinets – 25" High

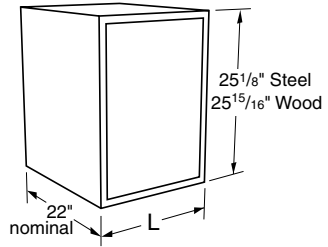

### Specifications:

Suspended Base Cabinets are designed to hang beneath Cantilevered Worksurface or Table Frames. They are available in either steel or wood construction and are furnished with all hardware required for attachment to the frame.

Cabinets on this page are a nominal 25" high, and are available in lengths shown.

See page 98 and 99 for designating cabinet style, door and drawer head material, and hardware selection.

### Cupboard Base Cabinets

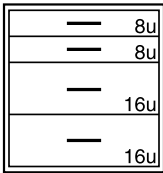

Steel Cabinet	Length	Wood Cabinet
<b>D08C252215-</b> ----	15"	<b>D08W262215-</b> 0
<b>D08C252218-</b> ----	18"	<b>D08W262218-</b> 0
<b>D08C252221-</b> ----	21"	<b>D08W262221-</b> 0
<b>D08C252224-</b> ----	24"	<b>D08W262224-</b> 0

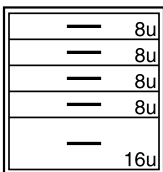
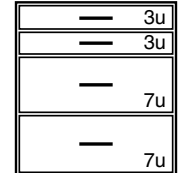

Steel Cabinet	Length	Wood Cabinet
<b>D10C252215-</b> ----	15"	<b>D10W262215-</b> 0
<b>D10C252218-</b> ----	18"	<b>D10W262218-</b> 0
<b>D10C252221-</b> ----	21"	<b>D10W262221-</b> 0
<b>D10C252224-</b> ----	24"	<b>D10W262224-</b> 0

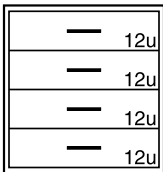
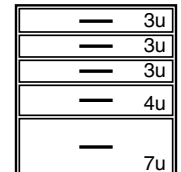

Steel Cabinet	Length	Wood Cabinet
<b>D30C252215-</b> ----	15"	<b>D30W262215-</b> 0
<b>D30C252218-</b> ----	18"	<b>D30W262218-</b> 0
<b>D30C252221-</b> ----	21"	<b>D30W262221-</b> 0
<b>D30C252224-</b> ----	24"	<b>D30W262224-</b> 0

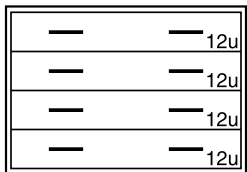
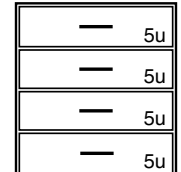

Steel Cabinet	Length	Wood Cabinet
<b>D30C252230-</b> ----	30"	<b>D30W262230-</b> 0
<b>D30C252236-</b> ----	36"	<b>D30W262236-</b> 0
<b>D30C252242-</b> ----	42"	<b>D30W262242-</b> 0
<b>D30C252248-</b> ----	48"	<b>D30W262248-</b> 0

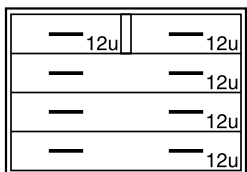
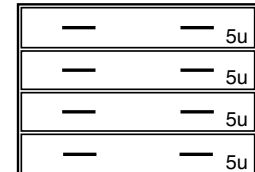

Steel Cabinet	Length	Wood Cabinet
<b>D31C252230-</b> ----	30"	<b>D31W262230-</b> 0
<b>D31C252236-</b> ----	36"	<b>D31W262236-</b> 0
<b>D31C252242-</b> ----	42"	<b>D31W262242-</b> 0
<b>D31C252248-</b> ----	48"	<b>D31W262248-</b> 0

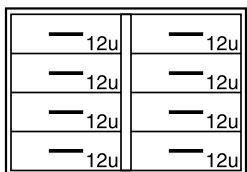
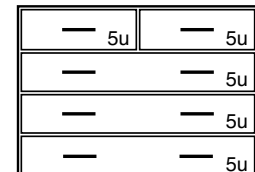

Steel Cabinet	Length	Wood Cabinet
<b>D32C252230-</b> ----	30"	<b>D32W262230-</b> 0
<b>D32C252236-</b> ----	36"	<b>D32W262236-</b> 0
<b>D32C252242-</b> ----	42"	<b>D32W262242-</b> 0
<b>D32C252248-</b> ----	48"	<b>D32W262248-</b> 0

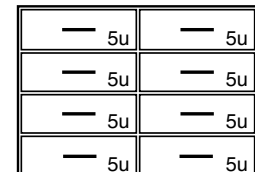

Illustrations and specifications are based on most current design and production information available. Kewaunee reserves the right to make changes at any time without notice.

# Suspended Base Cabinets – 25" High

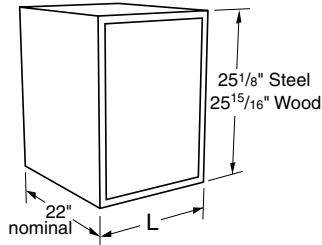

**Specifications:**

Suspended Base Cabinets are designed to hang beneath Cantilevered Worksurface or Table Frames. They are available in either steel or wood construction and are furnished with all hardware required for attachment to the frame.

Cabinets on this page are a nominal 25" high, and are available in lengths shown.

See page 98 and 99 for designating cabinet style, door and drawer head material, and hardware selection.

**Drawer Base Cabinets**

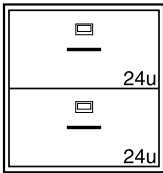

2 File Drawers with hangers

Steel Cabinet	Length	Wood Cabinet
<b>D81C252215L</b>	15"	<b>D81W262215- 0</b>
<b>D81C252218L</b>	18"	<b>D81W262218- 0</b>
<b>D81C252221L</b>	21"	<b>D81W262221- 0</b>
<b>D81C252224L</b>	24"	<b>D81W262224- 0</b>

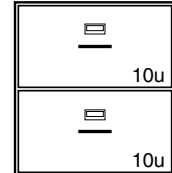

2 File Drawers with hangers

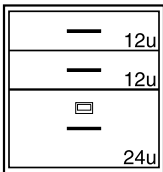

1 File Drawer with hangers

Steel Cabinet	Length	Wood Cabinet
<b>D85C252215-</b>	15"	<b>D85W262215- 0</b>
<b>D85C252218-</b>	18"	<b>D85W262218- 0</b>
<b>D85C252221-</b>	21"	<b>D85W262221- 0</b>
<b>D85C252224-</b>	24"	<b>D85W262224- 0</b>

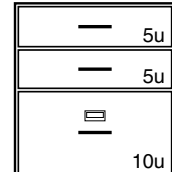

1 File Drawer with hangers

**Drawer & Cupboard Base Cabinets**

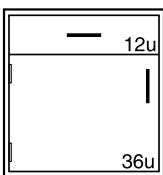

Steel Cabinet	Length	Wood Cabinet
<b>E40C252215L</b>	15"	<b>E40W262215L</b>
<b>E40C252218L</b>	18"	<b>E40W262218L</b>
<b>E40C252221L</b>	21"	<b>E40W262221L</b>
<b>E40C252224L</b>	24"	<b>E40W262224L</b>

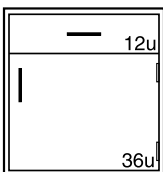
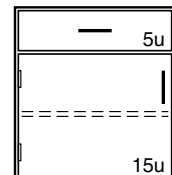

Steel Cabinet	Length	Wood Cabinet
<b>E40C252215-</b>	15"	<b>E40W262215-</b>
<b>E40C252218-</b>	18"	<b>E40W262218-</b>
<b>E40C252221-</b>	21"	<b>E40W262221-</b>
<b>E40C252224-</b>	24"	<b>E40W262224-</b>

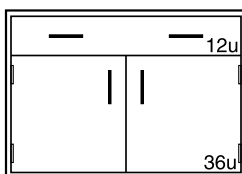
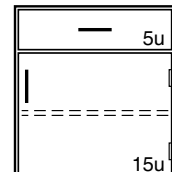

Steel Cabinet	Length	Wood Cabinet
<b>E40C252230-</b>	30"	<b>E40W262230-</b>
<b>E40C252236-</b>	36"	<b>E40W262236-</b>
<b>E40C252242-</b>	42"	<b>E40W262242-</b>
<b>E40C252248-</b>	48"	<b>E40W262248-</b>

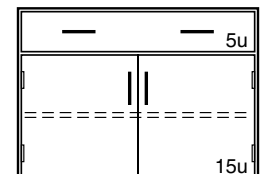



# Suspended Base Cabinets – 25" High

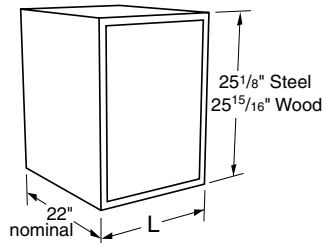

**Specifications:**  
 Suspended Base Cabinets are designed to hang beneath Cantilevered Worksurface or Table Frames. They are available in either steel or wood construction and are furnished with all hardware required for attachment to the frame.

Cabinets on this page are a nominal 25" high, and are available in lengths shown.

See page 98 and 99 for designating cabinet style, door and drawer head material, and hardware selection.

## Drawer & Cupboard Base Cabinets

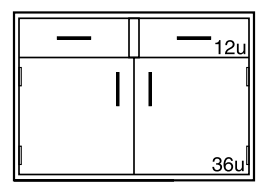

Steel Cabinet	Length	Wood Cabinet
<b>E41C252230-</b> -----	30"	<b>E41W262230-</b> -----
<b>E41C252236-</b> -----	36"	<b>E41W262236-</b> -----
<b>E41C252242-</b> -----	42"	<b>E41W262242-</b> -----
<b>E41C252248-</b> -----	48"	<b>E41W262248-</b> -----

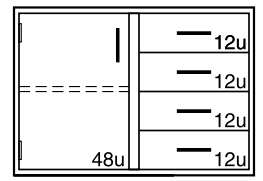
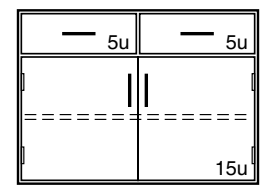

Steel Cabinet	Length	Wood Cabinet
<b>E44C252230L</b> -----	30"	<b>E44W262230L</b> -----
<b>E44C252236L</b> -----	36"	<b>E44W262236L</b> -----
<b>E44C252242L</b> -----	42"	<b>E44W262242L</b> -----
<b>E44C252248L</b> -----	48"	<b>E44W262248L</b> -----

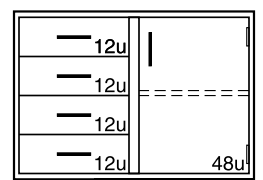
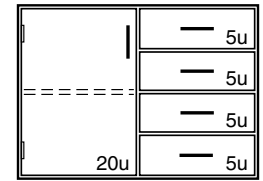

Steel Cabinet	Length	Wood Cabinet
<b>E44C252230-</b> -----	30"	<b>E44W262230-</b> -----
<b>E44C252236-</b> -----	36"	<b>E44W262236-</b> -----
<b>E44C252242-</b> -----	42"	<b>E44W262242-</b> -----
<b>E44C252248-</b> -----	48"	<b>E44W262248-</b> -----

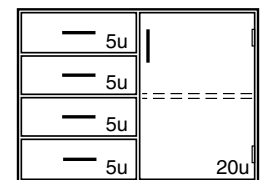

## Sink Base Cabinets

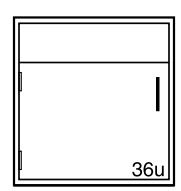

Steel Cabinet	Length	Wood Cabinet
<b>G00C252215L</b> -----	15"	<b>G00W262215L</b> -----
<b>G00C252218L</b> -----	18"	<b>G00W262218L</b> -----
<b>G00C252221L</b> -----	21"	<b>G00W262221L</b> -----
<b>G00C252224L</b> -----	24"	<b>G00W262224L</b> -----

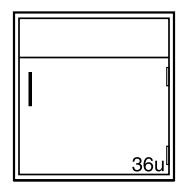
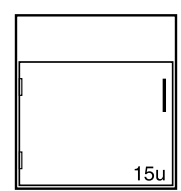

Steel Cabinet	Length	Wood Cabinet
<b>G00C252215-</b> -----	15"	<b>G00W262215-</b> -----
<b>G00C252218-</b> -----	18"	<b>G00W262218-</b> -----
<b>G00C252221-</b> -----	21"	<b>G00W262221-</b> -----
<b>G00C252224-</b> -----	24"	<b>G00W262224-</b> -----

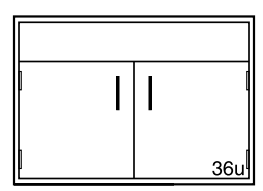
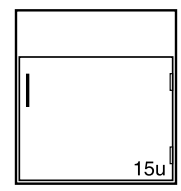

Steel Cabinet	Length	Wood Cabinet
<b>G00C252230-</b> -----	30"	<b>G00W262230-</b> -----
<b>G00C252236-</b> -----	36"	<b>G00W262236-</b> -----
<b>G00C252242-</b> -----	42"	<b>G00W262242-</b> -----
<b>G00C252248-</b> -----	48"	<b>G00W262248-</b> -----

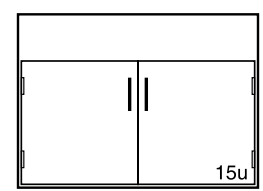

Illustrations and specifications are based on most current design and production information available. Kewaunee reserves the right to make changes at any time without notice.

# Drawers, Writing Boards & Keyboard Tray

## Specifications:

Suspended Drawers and Writing Boards are designed to hang beneath Cantilevered Worksurface. They are available in either steel or wood construction and are furnished with all hardware required for attachment to the frame.

See page 98 and 99 for designating cabinet style, drawer head material, and hardware selection.

The black, non-skid, vinyl coated, MDF Keyboard Tray is furnished with sliding support arm offering 21" of travel, 5<sup>3</sup>/<sub>4</sub>" of height adjustment, +/- 15° tilt, and 360° swivel. Optional Mouse Pad may be mounted to either side of Keyboard Tray and pivots under tray when not in use. Both are supplied with all hardware required for mounting to Worksurfaces, Tables, or Shelves.

### Suspended Drawers - 4" High

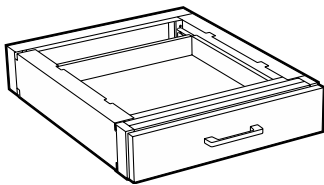

Length	Steel	Wood
15"	<b>F70C042215-1</b> ___	<b>F70W042215- 0</b> ___
18"	<b>F70C042218-1</b> ___	<b>F70W042218- 0</b> ___
21"	<b>F70C042221-1</b> ___	<b>F70W042221- 0</b> ___
24"	<b>F70C042224-1</b> ___	<b>F70W042224- 0</b> ___
30"	<b>F70C042230-1</b> ___	<b>F70W042230- 0</b> ___

### Suspended Writing Boards

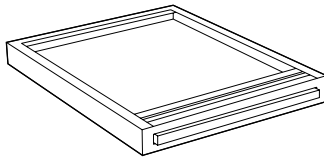

Length	Steel	Wood
15"	<b>F71C022215-00_0</b>	<b>F71W022215-00_0</b>
18"	<b>F71C022218-00_0</b>	<b>F71W022218-00_0</b>

### Keyboard Trays

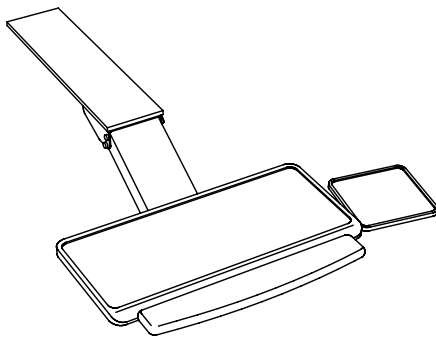

<b>Sliding Keyboard Tray</b> polycarbonate coated steel	11 <sup>1</sup> / <sub>2</sub> " x 20 <sup>1</sup> / <sub>2</sub> " <b>F72M1220-00</b>
<b>Optional Swing-out Mouse Platform</b> polycarbonate coated steel	8" x 8" <b>F72M0808-0T</b>

*product may vary slightly from illustration*

# Mobile Base Cabinets

## Features:

### Steel Base Cabinets

- Furnished with finished ends and back.
- Cabinet tops available in either, Kemresin, Phenolic Resin, High Pressure Laminate or Steel.
- Furnished with two concealed, fixed casters at rear, and two swivel, locking casters at front.
- Furnished with interlocking drawer system and counterbalanced weights in drawer cabinets.
- Available in all steel cabinet styles, in both inset and full overlay.

### Wood Base Cabinets

- Furnished with finished veneer top, end panels, and back. End panels banded and finished, front, back, top, and bottom.
- Optional 1" thick cabinet tops available. (recommended for wood cabinets with pullboards)
- Furnished with two concealed, fixed casters at rear, and two swivel, locking casters at front.
- Furnished with interlocking drawer system and counterbalanced weights in drawer cabinets.
- Available in three wood cabinet styles in Oak, Maple, or Beech veneer.

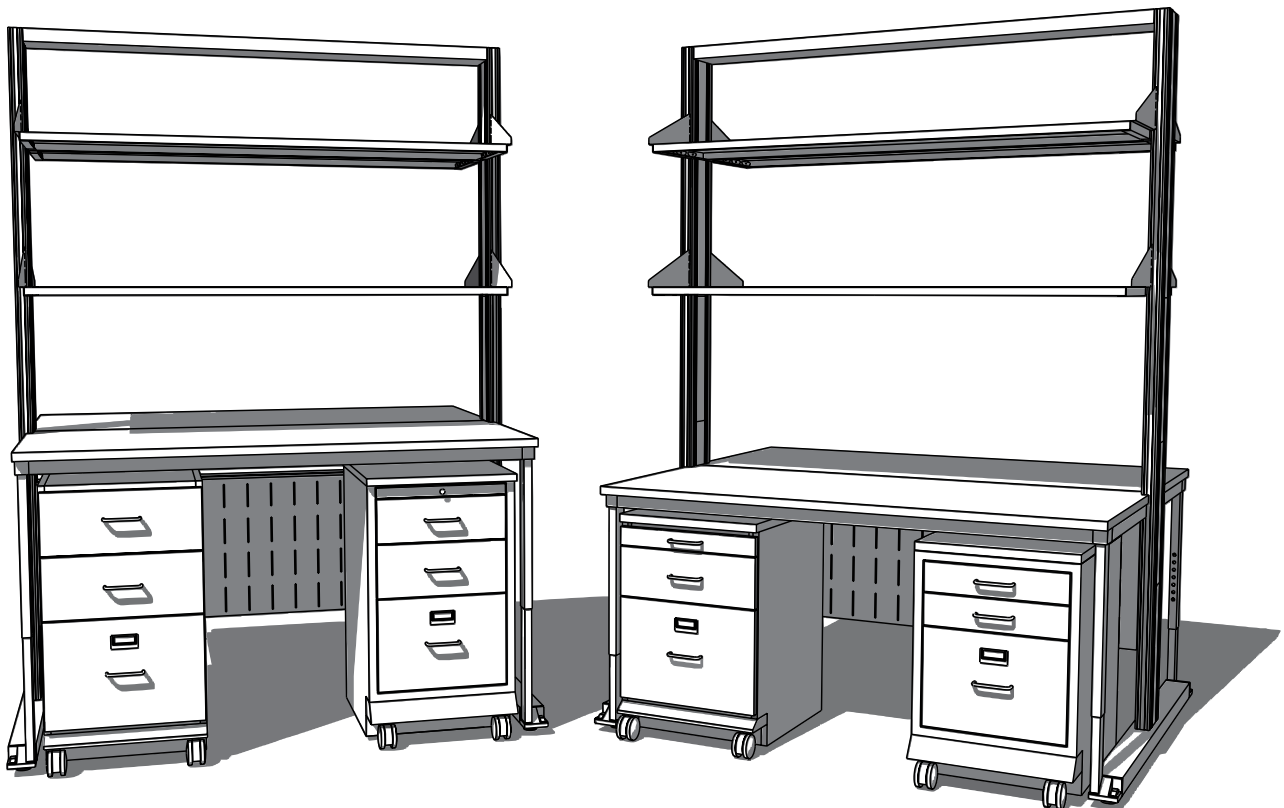

# Wood Sitting Height Mobile Cabinets

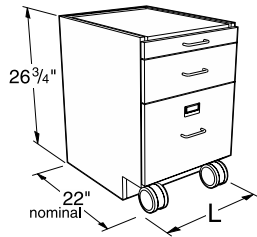

## Specifications:

These Mobile Cabinets are 26<sup>3</sup>/<sub>4</sub>" high and a nominal 22" deep. Lengths as shown. They are designed to fit under 30" high worksurface frames.

Drawer cabinets are furnished with counter weights, multiple-drawer cabinets include an interlock system. All mobile cabinets have finished backs.

**Note:** Last four digits of part number designates door and drawer head style, hinge, hardwood species, and pull selection. See page 99 for full explanation. Actual product may vary slightly from catalog illustration due to style and hardware selection.

### Cupboard Cabinets

### Cupboard Cabinets with Pullboards

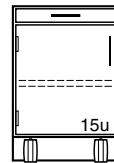
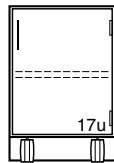
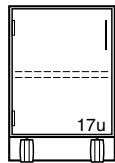

M10W272215L \_\_\_\_\_ 15"  
M10W272218L \_\_\_\_\_ 18"  
M10W272221L \_\_\_\_\_ 21"  
M10W272224L \_\_\_\_\_ 24"

M10W272215- \_\_\_\_\_ 15"  
M10W272218- \_\_\_\_\_ 18"  
M10W272221- \_\_\_\_\_ 21"  
M10W272224- \_\_\_\_\_ 24"

M15W272215L \_\_\_\_\_ 15"  
M15W272218L \_\_\_\_\_ 18"  
M15W272221L \_\_\_\_\_ 21"  
M15W272224L \_\_\_\_\_ 24"

M15W272215- \_\_\_\_\_ 15"  
M15W272218- \_\_\_\_\_ 18"  
M15W272221- \_\_\_\_\_ 21"  
M15W272224- \_\_\_\_\_ 24"

### Drawer/Cupboard Cabinets

### Drawer/Cupboard Cabinets with Pullboards

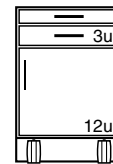
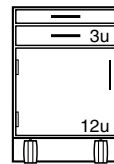
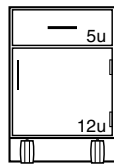
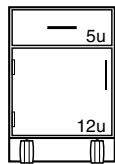

M20W272215L \_\_\_\_\_ 15"  
M20W272218L \_\_\_\_\_ 18"  
M20W272221L \_\_\_\_\_ 21"  
M20W272224L \_\_\_\_\_ 24"

M20W272215- \_\_\_\_\_ 15"  
M20W272218- \_\_\_\_\_ 18"  
M20W272221- \_\_\_\_\_ 21"  
M20W272224- \_\_\_\_\_ 24"

M25W272215L \_\_\_\_\_ 15"  
M25W272218L \_\_\_\_\_ 18"  
M25W272221L \_\_\_\_\_ 21"  
M25W272224L \_\_\_\_\_ 24"

M25W272215- \_\_\_\_\_ 15"  
M25W272218- \_\_\_\_\_ 18"  
M25W272221- \_\_\_\_\_ 21"  
M25W272224- \_\_\_\_\_ 24"

### Drawer Cabinets

### Drawer Cabinets with Pullboards

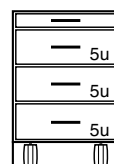
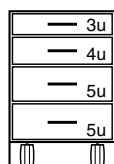
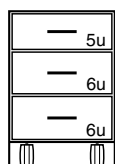

M30W272215- \_\_\_\_\_ 15"  
M30W272218- \_\_\_\_\_ 18"  
M30W272221- \_\_\_\_\_ 21"  
M30W272224- \_\_\_\_\_ 24"

M40W272215- \_\_\_\_\_ 15"  
M40W272218- \_\_\_\_\_ 18"  
M40W272221- \_\_\_\_\_ 21"  
M40W272224- \_\_\_\_\_ 24"

M35W272215- \_\_\_\_\_ 15"  
M35W272218- \_\_\_\_\_ 18"  
M35W272221- \_\_\_\_\_ 21"  
M35W272224- \_\_\_\_\_ 24"

**Note:** Wood Mobile Cabinets are constructed with finished top panels. Tops may be added but are not required to close the top of the cabinet.

Tops are recommended on wood mobile cabinets with pullboards.

**Tops must be ordered separately.** (see page 133)

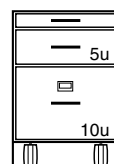
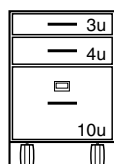
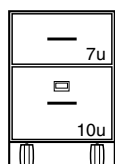

M60W272215- \_\_\_\_\_ 15"  
M60W272218- \_\_\_\_\_ 18"  
M60W272221- \_\_\_\_\_ 21"  
M60W272224- \_\_\_\_\_ 24"

M62W272215- \_\_\_\_\_ 15"  
M62W272218- \_\_\_\_\_ 18"  
M62W272221- \_\_\_\_\_ 21"  
M62W272224- \_\_\_\_\_ 24"

M65W272215- \_\_\_\_\_ 15"  
M65W272218- \_\_\_\_\_ 18"  
M65W272221- \_\_\_\_\_ 21"  
M65W272224- \_\_\_\_\_ 24"

# Wood Standing Height Mobile Cabinets

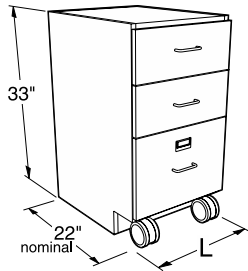

### Specifications:

These Mobile Cabinets are 33" high and a nominal 22" deep. Lengths as shown. They are designed to fit under 36" high worksurface frames.

Drawer cabinets are furnished with counter weights, multiple-drawer cabinets include an interlock system. All mobile cabinets have finished backs.

**Note:** Last four digits of part number designates door and drawer head style, hinge, hardwood species, and pull selection. See page 99 for full explanation. Actual product may vary slightly from catalog illustration due to style and hardware selection.

### Cupboard Cabinets

### Cupboard Cabinets with Pullboards

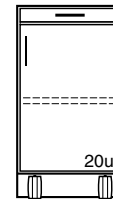
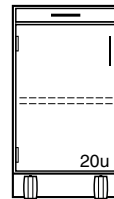
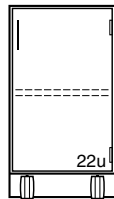
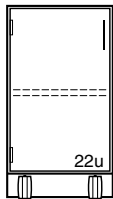

- M10W332215L \_\_\_\_\_ 15"L
- M10W332218L \_\_\_\_\_ 18"L
- M10W332221L \_\_\_\_\_ 21"L
- M10W332224L \_\_\_\_\_ 24"L

- M10W332215- \_\_\_\_\_ 15"L
- M10W332218- \_\_\_\_\_ 18"L
- M10W332221- \_\_\_\_\_ 21"L
- M10W332224- \_\_\_\_\_ 24"L

- M15W332215L \_\_\_\_\_ 15"L
- M15W332218L \_\_\_\_\_ 18"L
- M15W332221L \_\_\_\_\_ 21"L
- M15W332224L \_\_\_\_\_ 24"L

- M15W332215- \_\_\_\_\_ 15"L
- M15W332218- \_\_\_\_\_ 18"L
- M15W332221- \_\_\_\_\_ 21"L
- M15W332224- \_\_\_\_\_ 24"L

### Drawer/Cupboard Cabinets

### Drawer/Cupboard Cabinets with Pullboards

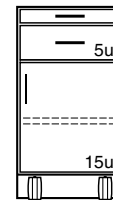
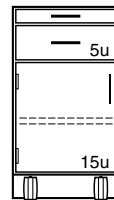
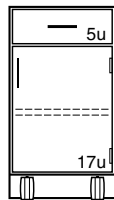
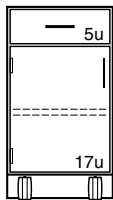

- M20W332215L \_\_\_\_\_ 15"L
- M20W332218L \_\_\_\_\_ 18"L
- M20W332221L \_\_\_\_\_ 21"L
- M20W332224L \_\_\_\_\_ 24"L

- M20W332215- \_\_\_\_\_ 15"L
- M20W332218- \_\_\_\_\_ 18"L
- M20W332221- \_\_\_\_\_ 21"L
- M20W332224- \_\_\_\_\_ 24"L

- M25W332215L \_\_\_\_\_ 15"L
- M25W332218L \_\_\_\_\_ 18"L
- M25W332221L \_\_\_\_\_ 21"L
- M25W332224L \_\_\_\_\_ 24"L

- M25W332215- \_\_\_\_\_ 15"L
- M25W332218- \_\_\_\_\_ 18"L
- M25W332221- \_\_\_\_\_ 21"L
- M25W332224- \_\_\_\_\_ 24"L

### Drawer Cabinets

### Drawer Cabinets with Pullboards

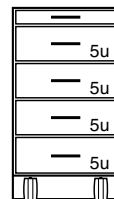
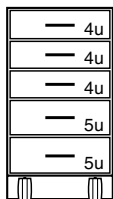

**Note:** Wood Mobile Cabinets are constructed with finished top panels. Tops may be added but are not required to close the top of the cabinet.

Tops are recommended on wood mobile cabinets with pullboards.

**Tops must be ordered separately.** (see page 133)

- M50W332215- \_\_\_\_\_ 15"L
- M50W332218- \_\_\_\_\_ 18"L
- M50W332221- \_\_\_\_\_ 21"L
- M50W332224- \_\_\_\_\_ 24"L

- M45W332215- \_\_\_\_\_ 15"L
- M45W332218- \_\_\_\_\_ 18"L
- M45W332221- \_\_\_\_\_ 21"L
- M45W332224- \_\_\_\_\_ 24"L

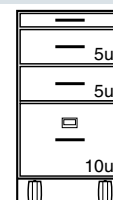
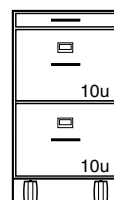
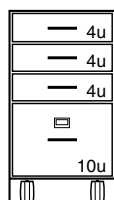
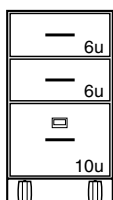

- M62W332215- \_\_\_\_\_ 15"L
- M62W332218- \_\_\_\_\_ 18"L
- M62W332221- \_\_\_\_\_ 21"L
- M62W332224- \_\_\_\_\_ 24"L

- M63W332215- \_\_\_\_\_ 15"L
- M63W332218- \_\_\_\_\_ 18"L
- M63W332221- \_\_\_\_\_ 21"L
- M63W332224- \_\_\_\_\_ 24"L

- M75W332215- \_\_\_\_\_ 15"L
- M75W332218- \_\_\_\_\_ 18"L
- M75W332221- \_\_\_\_\_ 21"L
- M75W332224- \_\_\_\_\_ 24"L

- M67W332215- \_\_\_\_\_ 15"L
- M67W332218- \_\_\_\_\_ 18"L
- M67W332221- \_\_\_\_\_ 21"L
- M67W332224- \_\_\_\_\_ 24"L

# Steel Sitting Height Mobile Cabinets

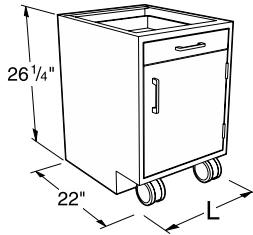

## Specifications

Steel Sitting Height Mobile Cabinets are 26 1/4" high and 22" deep. Lengths as shown. Designed to fit under 30" high workstation frames.

Drawer cabinets are furnished with counter weights, multiple-drawer cabinets include an interlock system. All mobile cabinets have finished backs.

**Note:** Last four digits of part number designates door and drawer head style, hinge, hardwood species and pull selection. See page 98 for full explanation. Actual product may vary slightly from catalog illustration due to style and hardware selection.

## Cupboard Cabinets

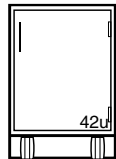
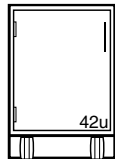

**Note:** Steel Mobile Cabinets are constructed with open top frames. Tops are required to close the top of the cabinets.

**Tops must be ordered separately.**  
(see page 132 & 133)

M10C262215L	15"L	M10C262215-	15"L
M10C262218L	18"L	M10C262218-	18"L
M10C262221L	21"L	M10C262221-	21"L
M10C262224L	24"L	M10C262224-	24"L

## Drawer/Cupboard Cabinets

## Drawer/Cupboard Cabinets with Pullboards

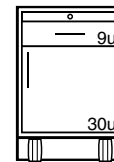
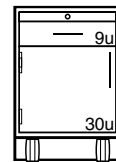
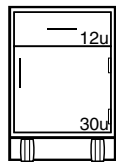
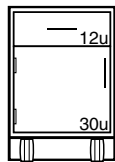

M20C262215L	15"L	M20C262215-	15"L
M20C262218L	18"L	M20C262218-	18"L
M20C262221L	21"L	M20C262221-	21"L
M20C262224L	24"L	M20C262224-	24"L

M25C262215L	15"L	M25C262215-	15"L
M25C262218L	18"L	M25C262218-	18"L
M25C262221L	21"L	M25C262221-	21"L
M25C262224L	24"L	M25C262224-	24"L

## Drawer Cabinets

## Drawer Cabinets with Pullboards

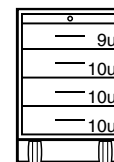
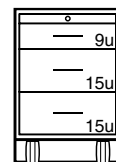
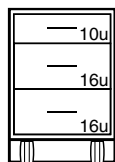

M30C262215-	15"L
M30C262218-	18"L
M30C262221-	21"L
M30C262224-	24"L

M35C262215-	15"L
M35C262218-	18"L
M35C262221-	21"L
M35C262224-	24"L

M45C262215-	15"L
M45C262218-	18"L
M45C262221-	21"L
M45C262224-	24"L

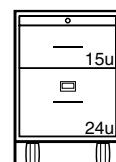
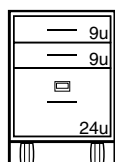

M62C262215-	15"L
M62C262218-	18"L
M62C262221-	21"L
M62C262224-	24"L

M66C262215-	15"L
M66C262218-	18"L
M66C262221-	21"L
M66C262224-	24"L

# Steel Standing Height Mobile Cabinets

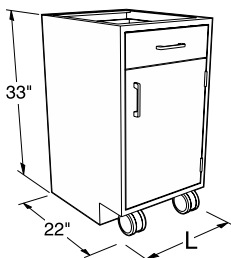

## Specifications

Steel Standing Height Mobile Cabinets are 33" high and 22" deep. Lengths as shown. Designed to fit under 36" high workstation frames.

Drawer cabinets are furnished with counter weights, multiple-drawer cabinets include an interlock system. All mobile cabinets have finished backs.

**Note:** Last four digits of part number designates door and drawer head style, hinge, hardwood species and pull selection. See page 98 for full explanation. Actual product may vary slightly from catalog illustration due to style and hardware selection.

## Cupboard Cabinets

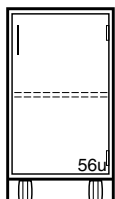
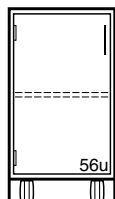

- M10C332215L \_\_\_\_\_ 15"L
- M10C332218L \_\_\_\_\_ 18"L
- M10C332221L \_\_\_\_\_ 21"L
- M10C332224L \_\_\_\_\_ 24"L

- M10C332215- \_\_\_\_\_ 15"L
- M10C332218- \_\_\_\_\_ 18"L
- M10C332221- \_\_\_\_\_ 21"L
- M10C332224- \_\_\_\_\_ 24"L

**Note:** Steel Mobile Cabinets are constructed with open top frames. Tops are required to close the top of the cabinets.

**Tops must be ordered separately.**  
(see page 132 & 133)

## Drawer/Cupboard Cabinets

## Drawer/Cupboard Cabinets with Pullboards

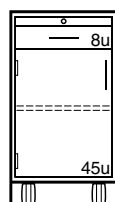
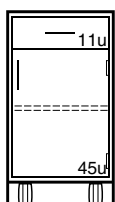
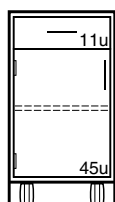

- M20C332215L \_\_\_\_\_ 15"L
- M20C332218L \_\_\_\_\_ 18"L
- M20C332221L \_\_\_\_\_ 21"L
- M20C332224L \_\_\_\_\_ 24"L

- M20C332215- \_\_\_\_\_ 15"L
- M20C332218- \_\_\_\_\_ 18"L
- M20C332221- \_\_\_\_\_ 21"L
- M20C332224- \_\_\_\_\_ 24"L

- M25C332215L \_\_\_\_\_ 15"L
- M25C332218L \_\_\_\_\_ 18"L
- M25C332221L \_\_\_\_\_ 21"L
- M25C332224L \_\_\_\_\_ 24"L

- M25C332215- \_\_\_\_\_ 15"L
- M25C332218- \_\_\_\_\_ 18"L
- M25C332221- \_\_\_\_\_ 21"L
- M25C332224- \_\_\_\_\_ 24"L

## Drawer Cabinets

## Drawer Cabinets with Pullboards

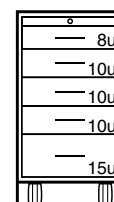
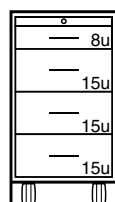
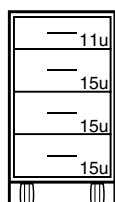

- M40C332215- \_\_\_\_\_ 15"L
- M40C332218- \_\_\_\_\_ 18"L
- M40C332221- \_\_\_\_\_ 21"L
- M40C332224- \_\_\_\_\_ 24"L

- M46C332215- \_\_\_\_\_ 15"L
- M46C332218- \_\_\_\_\_ 18"L
- M46C332221- \_\_\_\_\_ 21"L
- M46C332224- \_\_\_\_\_ 24"L

- M56C332215- \_\_\_\_\_ 15"L
- M56C332218- \_\_\_\_\_ 18"L
- M56C332221- \_\_\_\_\_ 21"L
- M56C332224- \_\_\_\_\_ 24"L

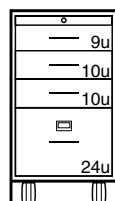
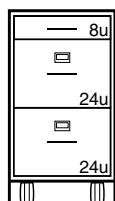

- M71C332215- \_\_\_\_\_ 15"L
- M71C332218- \_\_\_\_\_ 18"L
- M71C332221- \_\_\_\_\_ 21"L
- M71C332224- \_\_\_\_\_ 24"L

- M68C332215- \_\_\_\_\_ 15"L
- M68C332218- \_\_\_\_\_ 18"L
- M68C332221- \_\_\_\_\_ 21"L
- M68C332224- \_\_\_\_\_ 24"L

Illustrations and specifications are based on most current design and production information available. Kewaunee reserves the right to make changes at any time without notice.

# Mobile Cabinet Tops & Accessories

## Specifications:

**1" Thick Mobile Cabinet Tops** are available in three depths, 22", 23", or 24" and three materials: Kemresin, Phenolic Resin or Plastic Laminate. They may be used on any Mobile

Cabinet and add 1" to the overall height of the cabinets. All edges of top are finished.

### 1" Thick — Mobile Cabinet Top (adds 1" to height of Mobile Cabinet)

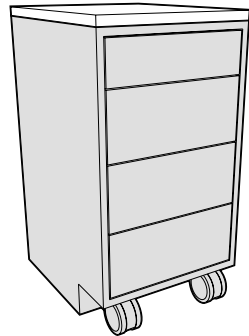

#### 22" Deep flush to front of case

Length	Kemresin®	Kemresin Colors	Black Phenolic Resin	Black Plastic Laminate
15"	<b>F94R2215-00-__</b>	<b>BK = Black</b>	<b>F94T2215-00</b>	<b>F94P2215-00</b>
18"	<b>F94R2218-00-__</b>	<b>GR = Grey</b>	<b>F94T2218-00</b>	<b>F94P2218-00</b>
21"	<b>F94R2221-00-__</b>	<b>PT = Putty</b>	<b>F94T2221-00</b>	<b>F94P2221-00</b>
24"	<b>F94R2224-00-__</b>	<b>SL = Slate</b>	<b>F94T2224-00</b>	<b>F94P2224-00</b>
30"	<b>F94R2230-00-__</b>		<b>F94T2230-00</b>	<b>F94P2230-00</b>
36"	<b>F94R2236-00-__</b>		<b>F94T2236-00</b>	<b>F94P2236-00</b>
42"	<b>F94R2242-00-__</b>		<b>F94T2242-00</b>	<b>F94P2242-00</b>
48"	<b>F94R2248-00-__</b>		<b>F94T2248-00</b>	<b>F94P2248-00</b>

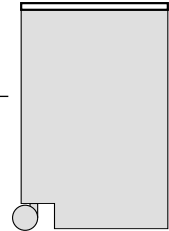

*Inset Cabinet End View*

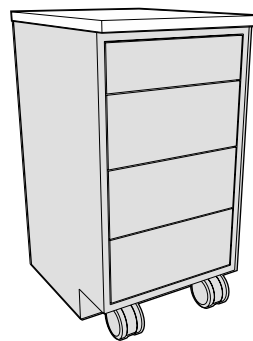

#### 23" Deep flush to overlay door/drawer fronts - 1" overhang of case

Length	Kemresin®	Kemresin Colors	Black Phenolic Resin	Black Plastic Laminate
15"	<b>F94R2315-00-__</b>	<b>BK = Black</b>	<b>F94T2315-00</b>	<b>F94P2315-00</b>
18"	<b>F94R2318-00-__</b>	<b>GR = Grey</b>	<b>F94T2318-00</b>	<b>F94P2318-00</b>
21"	<b>F94R2321-00-__</b>	<b>PT = Putty</b>	<b>F94T2321-00</b>	<b>F94P2321-00</b>
24"	<b>F94R2324-00-__</b>	<b>SL = Slate</b>	<b>F94T2324-00</b>	<b>F94P2324-00</b>
30"	<b>F94R2330-00-__</b>		<b>F94T2330-00</b>	<b>F94P2330-00</b>
36"	<b>F94R2336-00-__</b>		<b>F94T2336-00</b>	<b>F94P2336-00</b>
42"	<b>F94R2342-00-__</b>		<b>F94T2342-00</b>	<b>F94P2342-00</b>
48"	<b>F94R2348-00-__</b>		<b>F94T2348-00</b>	<b>F94P2348-00</b>

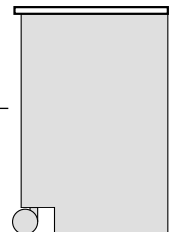

*Inset Cabinet End View*

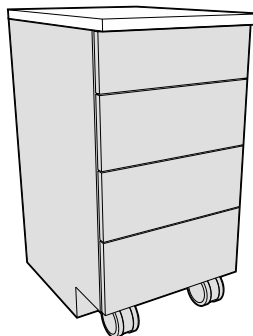

#### 24" Deep 1" overhang of overlay door/drawer fronts

Length	Kemresin®	Kemresin Colors	Black Phenolic Resin	Black Plastic Laminate
15"	<b>F94R2415-00-__</b>	<b>BK = Black</b>	<b>F94T2415-00</b>	<b>F94P2415-00</b>
18"	<b>F94R2418-00-__</b>	<b>GR = Grey</b>	<b>F94T2418-00</b>	<b>F94P2418-00</b>
21"	<b>F94R2421-00-__</b>	<b>PT = Putty</b>	<b>F94T2421-00</b>	<b>F94P2421-00</b>
24"	<b>F94R2424-00-__</b>	<b>SL = Slate</b>	<b>F94T2424-00</b>	<b>F94P2424-00</b>
30"	<b>F94R2430-00-__</b>		<b>F94T2430-00</b>	<b>F94P2430-00</b>
36"	<b>F94R2436-00-__</b>		<b>F94T2436-00</b>	<b>F94P2436-00</b>
42"	<b>F94R2442-00-__</b>		<b>F94T2442-00</b>	<b>F94P2442-00</b>
48"	<b>F94R2448-00-__</b>		<b>F94T2448-00</b>	<b>F94P2448-00</b>

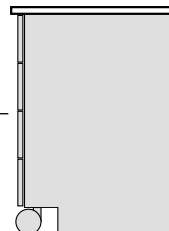

*Overlay Cabinet End View*



# Mobile Cabinet Tops & Accessories

**Specifications:**

**Steel Mobile Cabinet Tops** are fabricated from 18 gauge steel and finished to match the cabinet. They are designed for Steel Mobile Cabinets only.

**Mobile Cabinet Grabbar** allows easier movement and relocation of mobile cabinets. Fabricated from powder coated steel or stainless steel, they may be used on any

Mobile Cabinet, with or without Tops. Bars must be attached in field with supplied screws and/or bolts.

**22" Deep — Steel — Mobile Cabinet Top (adds less than 1/4" to height of Mobile Cabinet)**

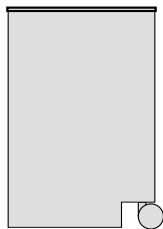
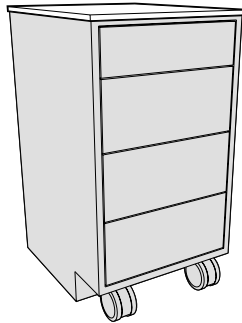

*Inset Cabinet  
End View*

**22" Deep Top**  
*for Steel Mobile Cabinets only*

Lg	Painted Steel	Stainless Steel
15"	<b>F94M2215-00</b>	<b>F94S2215-00</b>
18"	<b>F94M2218-00</b>	<b>F94S2218-00</b>
21"	<b>F94M2221-00</b>	<b>F94S2221-00</b>
24"	<b>F94M2224-00</b>	<b>F94S2224-00</b>
30"	<b>F94M2230-00</b>	<b>F94S2230-00</b>
36"	<b>F94M2236-00</b>	<b>F94S2236-00</b>
42"	<b>F94M2242-00</b>	<b>F94S2242-00</b>
48"	<b>F94M2248-00</b>	<b>F94S2248-00</b>

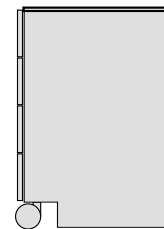

*Overlay Cabinet  
End View*

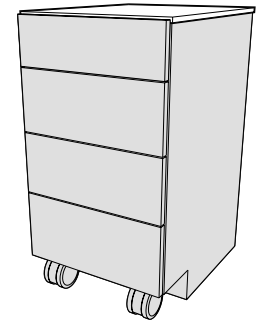

**23" Deep — Steel — Mobile Cabinet Top (adds 1/2" to height of Mobile Cabinet)**

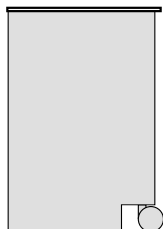
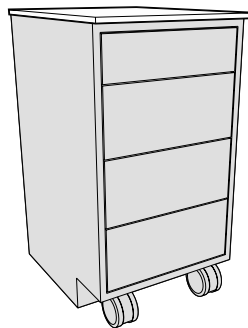

*Inset Cabinet  
End View*

**23" Deep Top**  
*for Steel Mobile Cabinets only*

Lg	Painted Steel	Stainless Steel
15"	<b>F94M2315-00</b>	<b>F94S2315-00</b>
18"	<b>F94M2318-00</b>	<b>F94S2318-00</b>
21"	<b>F94M2321-00</b>	<b>F94S2321-00</b>
24"	<b>F94M2324-00</b>	<b>F94S2324-00</b>
30"	<b>F94M2330-00</b>	<b>F94S2330-00</b>
36"	<b>F94M2336-00</b>	<b>F94S2336-00</b>
42"	<b>F94M2342-00</b>	<b>F94S2342-00</b>
48"	<b>F94M2348-00</b>	<b>F94S2348-00</b>

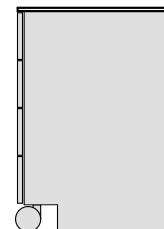

*Overlay Cabinet  
End View*

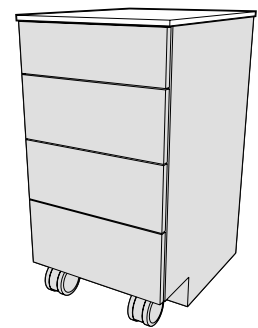

**Mobile Cabinet Grabbar**

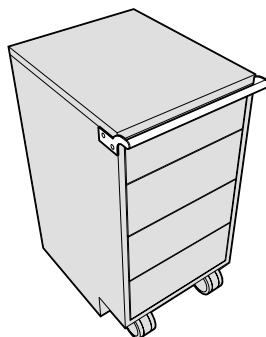

Length	Painted Steel	Stainless Steel
15"	<b>F73M0015-00</b>	<b>F73S0015-00</b>
18"	<b>F73M0018-00</b>	<b>F73S0018-00</b>
21"	<b>F73M0021-00</b>	<b>F73S0021-00</b>
24"	<b>F73M0024-00</b>	<b>F73S0024-00</b>

